



Sky Air Advance-series
Air Conditioning
Technical Data
RZASG-MY1



TABLE OF CONTENTS

RZASG-MY1

1	Features	4
	RZASG-MY1	4
2	Specifications	5
3	Electrical data	15
4	Options	16
5	Combination table	17
6	Capacity tables	18
	Cooling/Heating Capacity Tables	18
	Capacity Correction Factor	20
7	Dimensional drawings	21
8	Centre of gravity	22
9	Piping diagrams	23
	Piping Diagram Twin Application	24
	Piping Diagram Triple Application	25
	Piping Diagram Double Twin Application	26
10	Wiring diagrams	27
	Wiring Diagrams - Three Phase	27
11	Sound data	28
	Sound Power Spectrum	28
	Sound Pressure Spectrum - Cooling	30
	Sound Pressure Spectrum - Heating	32
	Sound Pressure Spectrum Quiet Mode	34
12	Installation	36
	Installation Method	36
13	Operation range	38
14	Appropriate Indoors	39

1 Features

1 - 1 RZASG-MY1

Technology and comfort combined for commercial applications

1

- > High efficiency: - Energy labels up to A++ (cooling) / A+ (heating) - compressor offers substantial efficiency improvements
- > Choosing for an R-32 product, reduces the environmental impact with 68% compared to R-410A, leads directly to lower energy consumption thanks to its high energy efficiency and has a lower refrigerant charge
- > Very compact and easy to install
- > Replace existing systems with R-32 technology without needing to replace the piping
- > Guarantees operation in both heating and cooling mode down to -15°C
- > Refrigerant cooled PCB guarantees reliable cooling, as it is not influenced by ambient temperature.
- > Maximum piping length up to 50m, minimum piping length has no limitation
- > Outdoor units for pair, twin, triple, double twin application



Inverter



Swing compressor



Seasonal efficiency - Smart use of energy



Replacement technology



Auto cooling-heating changeover



Night quiet mode



Twin/triple/double twin application

2 Specifications

2 - 1 Specifications

Technical Specifications					RZASG100MY1	RZASG125MY1	RZASG140MY1	
Casing	Colour		Ivory white					
	Material		Painted galvanized steel plate					
Dimensions	Unit	Height	mm	990				
		Width	mm	940				
		Depth	mm	320				
	Packed unit	Height	mm	1,170				
		Width	mm	1,015				
		Depth	mm	422				
Weight	Unit	kg		70		77		
	Packed unit	kg		78		85		
Packing	Weight	kg		9				
Heat exchanger	Fin	Type		WF fin				
		Treatment		Anti-corrosion treatment (PE)				
Fan	Type		Propeller					
	Discharge direction		Horizontal					
	Quantity		1					
	Air flow rate	Cooling	Nom.	m ³ /min	69	71	76	
Heating			Nom.	m ³ /min	82			
		Partial	m ³ /min	-	55 (1)			
Fan motor	Quantity		1					
	Model		Brushless DC motor					
	Output		W	200				
	Drive		Direct drive					
Compressor	Quantity		1					
	Type		Hermetically sealed swing compressor					
Operation range	Cooling	Ambient	Min.	°CDB	-15			
			Max.	°CDB	46			
	Heating	Ambient	Min.	°CWB	-15			
			Max.	°CWB	15.5			
Sound power level	Cooling			70	71	73		
	Heating			-	71 (1)	73 (1)		
Sound pressure level	Cooling	Nom.	dB(A)	53				
	Heating	Nom.	dB(A)	57				
Refrigerant	Type		R-32					
	Charge		kg	2.60		2.90		
	Control		Expansion valve (electronic type)					
Refrigerant	GWP		675					
	Circuits	Quantity		1				
Refrigerant oil	Type		FW68DA					
	Charged volume		l	0.90		1.35		
Piping connections	Liquid	Quantity		1				
		Type		Flare connection				
		OD		mm	9.52			
	Gas	Quantity		1				
		Type		Flare connection				
		OD		mm	15.9			
	Drain	Quantity		5				
		Type		Hole				
		OD		mm	26			
	Piping length	OU - IU	Min.	m	5			
			Max.	m	50			
		System	Equivalent	m	70			
			Chargeless	m	30			
	Additional refrigerant charge		kg/m	See installation manual				
	Level dif-	IU - OU	Max.	m	30.0			
ference	IU - IU		m	0.5				
Heat insulation		Both liquid and gas pipes						
Defrost method		Reversed cycle						
Defrost control		Sensor for outdoor heat exchanger temperature						
Capacity control	Method		Inverter controlled					
PED	Category		Category II					
Safety devices	Item	01	High pressure switch					
		02	Low pressure switch					
	03	Fan driver overload protector						
	04	Fuse						
	05	Compressor motor thermal protector						

Standard accessories: Tie-wraps;Quantity: 2;

Standard accessories: Installation manual;Quantity: 1;

Standard accessories: Refrigerant label for F-gas regulation;Quantity: 1;

Standard accessories: General safety precautions;Quantity: 1;

Standard accessories: LOT10 Energy Label;Quantity: 1;

2 Specifications

2 - 1 Specifications

2

Electrical Specifications			RZASG100MY1	RZASG125MY1	RZASG140MY1
Power supply	Name			Y1	
	Phase			3~	
	Frequency	Hz		50	
	Voltage	V		380-415	
	Voltage range	V		342	
V			457		
Current	Zmax	List	Complies to EN61000-3-11		
	Minimum Ssc value	kVa	Equipment complying with EN / IEC 61000-3-2/ See note 3 / See note 4		
Wiring connections	For power supply	Remark	See installation manual outdoor unit		
	For connection with indoor	Remark	See installation manual outdoor unit		
Power supply intake			See installation manual outdoor unit		
Current - 50Hz	Maximum fuse amps (MFA)	A	16		

(1)According to ENER Lot 21 |

European/international technical standard setting the limits for harmonic currents produced by equipment connected to public low-voltage system with input current larger than 16A and ≤ 75A per phase. |

Ssc: Short-circuit power |

European/international technical standard setting the limits for harmonic currents produced by equipment connected to public low-voltage system with input current ≤ 16A per phase.

Technical specifications			FCAG100B + RZASG100MY1	FCAG125B + RZASG125MY1	FCAG140B + RZASG140MY1		
Cooling capacity	Nom.	kW	9.50 (1)	12.1 (1)	13.4 (1)		
Heating capacity	Nom.	kW	10.8 (2)	13.5 (2)	15.5 (2)		
Space cooling	Energy efficiency class		A++	-	-		
	Capacity Pdesign	kW	9.50	12.1	13.4		
	SEER		6.55	5.76	6.53		
	ηs,c	%	-	227	258		
	Annual energy consumption	kWh/a	507	1,261	1,231		
Space heating (Average climate)	Energy efficiency class		A+	-	-		
	Capacity Pdesign	kW		6.00	7.80		
	SCOP/A		4.17	4.05	4.31		
	SCOPnet/A		4.17	4.05	4.31		
	ηs,h	%	-	159	169		
	Annual energy consumption	kWh/a	2,016	2,074	2,534		
	Required back up heating cap at design conditions	kW		0.00			
Space cooling	A Condi- tion (35°C -27/19)	Pdc	kW	9.50	12.10	13.40	
		EERd		3.26	2.44	2.75	
	B Condi- tion (30°C -27/19)	Pdc	kW	7.00	8.92	9.88	
		EERd		5.49	4.30	4.88	
	C Condi- tion (25°C -27/19)	Pdc	kW	4.50	5.74	6.35	
		EERd		7.77	6.74	7.69	
	D Condi- tion (20°C -27/19)	Pdc	kW	3.11	3.18	3.74	
		EERd		11.16	10.49	12.01	
	Space heating (Average climate)	TOL	Tol (temperature operating limit)	°C		-10	
			Pdh (declared heating cap)	kW		6.00	7.80
			COPd (declared COP)		2.52	2.59	2.26
			Power input	kW	2.38	2.32	3.44
		TBivalent	Tbiv (bivalent temperature)	°C		-10	
			Pdh (declared heating cap)	kW		6.00	7.80
COPd (declared COP)				2.52	2.59	2.26	
Power input			kW	2.38	2.32	3.44	
A Con- dition (-7°C)		Pdh (declared heating cap)	kW	5.31	5.30	6.90	
		COPd (declared COP)		2.75	2.78	2.60	
Space heating (Average climate)		A Con- dition (-7°C)	Power input	kW	1.93	1.91	2.65
		B Condi- tion (2°C)	Pdh (declared heating cap)	kW		3.23	4.20
			COPd (declared COP)		3.97	3.88	4.32
	C Condi- tion (7°C)	Power input	kW	0.81	0.83	0.97	
	D Con- dition (12°C)	Pdh (declared heating cap)	kW	2.10	2.13	3.40	
		COPd (declared COP)		5.58	5.20	5.92	
		Power input	kW	0.38	0.41	0.57	
	Pdh (declared heating cap)	kW	2.50	2.55	3.99		
	COPd (declared COP)		6.95	6.66	7.26		
	Power input	kW	0.36	0.38	0.55		

2 Specifications

2 - 1 Specifications

Technical specifications					FCAG100B + RZASG100MY1	FCAG125B + RZASG125MY1	FCAG140B + RZASG140MY1
Power consumption in other than active mode	Crank-case heater mode	Cooling	PCK	kW		0.000	
		Heating	PCK	kW		0.000	
	Off mode	Cooling	POFF	kW		0.012	
		Heating	POFF	kW		0.012	
	Standby mode	Cooling	PSB	kW		0.012	
		Heating	PSB	kW		0.012	
	Thermo-stat-off mode	Cooling	PTO	kW		0.000	
		Heating	PTO	kW		0.012	
Indication if the heater is equipped with a supplementary heater (pair application)					-		No
Supplementary heater (pair application)					-		0.0
Cooling Cdc (Degradation cooling)						0.25	
Heating Cdh (Degradation heating)						0.25	
Cooling function included						Yes	
Heating function included						Yes	
Average climate included						Yes	
Cold season included						No	
Warm season included						No	
Ecolabel logo						No	

(1)Nominal cooling capacities are based on: indoor temperature: 27°CDB, 19°CWB, outdoor temperature: 35°CDB, equivalent refrigerant piping: 5m, level difference: 0m. |

(2)Nominal heating capacities are based on: indoor temperature: 20°CDB, outdoor temperature: 7°CDB, 6°CWB, equivalent refrigerant piping: 5m, level difference: 0m. |

See separate drawing for operation range |

See separate drawing for electrical data

Technical specifications					FBA100A + RZASG100MY1	FBA125A + RZASG125MY1	FBA140A + RZASG140MY1	
Cooling capacity	Nom.			kW	9.50 (1)	12.1 (1)	13.4 (1)	
Heating capacity	Nom.			kW	10.8 (2)	13.5 (2)	15.5 (2)	
Space cooling	Energy efficiency class				A+		-	
	Capacity	Pdesign		kW	9.50	12.1	13.4	
	SEER				5.83	5.49	5.81	
	ηs,c			%	-	217	229	
	Annual energy consumption			kWh/a	570	1,322	1,384	
Space heating (Average climate)	Energy efficiency class				A		-	
	Capacity	Pdesign		kW	6.00		7.80	
	SCOP/A				3.85	3.63	3.85	
	SCOPnet/A				3.85	3.63	3.85	
	ηs,h			%	-	142	151	
	Annual energy consumption			kWh/a	2,182	2,314	2,836	
	Required back up heating cap at design conditions			kW		0.00		
Space cooling	A Condi- tion (35°C -27/19)	Pdc EERd		kW	9.50	12.10	13.40	
					3.20	2.61	2.81	
	B Condi- tion (30°C -27/19)	Pdc EERd		kW	7.00	8.92	9.88	
					5.13	4.34	4.66	
	C Condi- tion (25°C -27/19)	Pdc EERd		kW	4.50	2.06	2.12	
					7.01	6.36	6.84	
	D Condi- tion (20°C -27/19)	Pdc EERd		kW	3.10	0.90	0.93	
					8.59	3.17	3.97	
	Power input			kW	0.36	8.72	8.83	
	Power input			kW			0.45	
	Space heating (Average climate)	TOL	Tol (temperature operating limit)		°C		-10	
			PdH (declared heating cap)		kW	6.00		7.80
			COPd (declared COP)			2.45	2.50	2.06
		Power input		kW	2.45	2.40	3.78	
TBivalent		Tbiv (bivalent temperature)		°C		-10		
		PdH (declared heating cap)		kW	6.00		7.80	
		COPd (declared COP)			2.45	2.50	2.06	
Power input		kW	2.45	2.40	3.78			
A Con- dition (-7°C)		PdH (declared heating cap)		kW	5.31	5.30	6.90	
		COPd (declared COP)			2.69	2.72	2.46	

2 Specifications

2 - 1 Specifications

2

Technical specifications				FBA100A + RZASG100MY1	FBA125A + RZASG125MY1	FBA140A + RZASG140MY1	
Space heating (Average climate)	A Con- dition (-7°C)	Power input	kW	1.97	1.95	2.81	
	B Condi- tion (2°C)	Pdh (declared heating cap)	kW	3.23		4.20	
		COPd (declared COP)		3.77	3.53	3.94	
		Power input	kW	0.86	0.91	1.07	
	C Condi- tion (7°C)	Pdh (declared heating cap)	kW	2.26	2.27	3.50	
		COPd (declared COP)		4.83	4.37	4.98	
		Power input	kW	0.47	0.52	0.70	
	D Condi- tion (12°C)	Pdh (declared heating cap)	kW	2.57	2.66	4.10	
		COPd (declared COP)		5.70	5.36	6.10	
		Power input	kW	0.45	0.50	0.67	
Power consump- tion in other than active mode	Crank- case heater mode	Cooling PCK	kW	0.000			
		Heating PCK	kW	0.000			
	Off mode	Cooling POFF	kW	0.014			
		Heating POFF	kW	0.014			
	Standby mode	Cooling PSB	kW	0.014			
		Heating PSB	kW	0.014			
	Thermo- stat-off mode	Cooling PTO	kW	0.000			
		Heating PTO	kW	0.014			
	Indication if the heater is equipped with a supplementary heater (pair application)				-		No
	Supplementary heater (pair appli- cation)	Back-up capacity	Heating elbu	kW	-		0.0
Cooling	Cdc (Degradation cooling)			0.25			
Heating	Cdh (Degradation heating)			0.25			
Cooling function included				Yes			
Heating function included				Yes			
Average climate included				Yes			
Cold season included				No			
Warm season included				No			
Ecolabel logo				No			

(1)Nominal cooling capacities are based on: indoor temperature: 27°CDB, 19°CWB, outdoor temperature: 35°CDB, equivalent refrigerant piping: 5m, level difference: 0m. |

(2)Nominal heating capacities are based on: indoor temperature: 20°CDB, outdoor temperature: 7°CDB, 6°CWB, equivalent refrigerant piping: 5m, level difference: 0m. |
See separate drawing for operation range |

See separate drawing for electrical data

Technical specifications				FDA125A + RZASG125MY1	
Cooling capacity	Nom.		kW	12.1 (1)	
Heating capacity	Nom.		kW	13.5 (2)	
Space cooling	Capacity Pdesign		kW	12.1	
	SEER			5.03	
	ηs,c		%	198	
	Annual energy consumption		kWh/a	1,444	
Space heating (Average climate)	Capacity Pdesign		kW	6.00	
	SCOP/A			3.58	
	SCOPnet/A			3.58	
	ηs,h		%	140	
	Annual energy consumption		kWh/a	2,346	
	Required back up heating cap at design conditions		kW	0.00	
Space cooling	A Condi- tion (35°C - 27/19)	Pdc	kW	12.10	
		EERd		2.56	
	B Condi- tion (30°C - 27/19)	Pdc	kW	8.92	
		EERd		4.03	
	C Condi- tion (25°C - 27/19)	Pdc	kW	5.74	
		EERd		5.89	
	D Condi- tion (20°C - 27/19)	Pdc	kW	0.97	
		EERd		3.10	
				kW	7.31
				kW	0.42

2 Specifications

2 - 1 Specifications

Technical specifications				FDA125A + RZASG125MY1
Space heating (Average climate)	TOL	Tol (temperature operating limit) °C		-10
		Pd _h (declared heating cap) kW		6.00
		COP _d (declared COP)		2.54
	Power input kW		2.36	
	TBivalent	T _{biv} (bivalent temperature) °C		-10
		Pd _h (declared heating cap) kW		6.00
		COP _d (declared COP)		2.54
	Power input kW		2.36	
	A Con- dition (-7°C)	Pd _h (declared heating cap) kW		5.30
COP _d (declared COP)		2.76		
Power input kW		1.92		
B Condi- tion (2°C)	Pd _h (declared heating cap) kW		3.23	
	COP _d (declared COP)		3.54	
	Power input kW		0.91	
Space heating (Average climate)	C Condi- tion (7°C)	Pd _h (declared heating cap) kW		2.29
		COP _d (declared COP)		4.27
		Power input kW		0.54
	D Con- dition (12°C)	Pd _h (declared heating cap) kW		2.65
		COP _d (declared COP)		5.00
		Power input kW		0.53
Power consump- tion in other than active mode	Crank- case heater mode	Cooling PCK	kW	0.000
		Heating PCK	kW	0.000
	Off mode	Cooling POFF	kW	0.015
		Heating POFF	kW	0.015
	Standby mode	Cooling PSB	kW	0.015
		Heating PSB	kW	0.015
	Thermo- stat-off mode	Cooling PTO	kW	0.000
		Heating PTO	kW	0.015
	Indication if the heater is equipped with a supplementary heater (pair application)			
Supplementary heater (pair appli- cation)	Back-up capacity	Heating elbu	kW	0.0
Cooling	C _{dc} (Degradation cooling)			0.25
Heating	C _{dh} (Degradation heating)			0.25
Cooling function included				Yes
Heating function included				Yes
Average climate included				Yes
Cold season included				No
Warm season included				No
Ecolabel logo				No

(1)Nominal cooling capacities are based on: indoor temperature: 27°CDB, 19°CWB, outdoor temperature: 35°CDB, equivalent refrigerant piping: 5m, level difference: 0m. |

(2)Nominal heating capacities are based on: indoor temperature: 20°CDB, outdoor temperature: 7°CDB, 6°CWB, equivalent refrigerant piping: 5m, level difference: 0m. |

See separate drawing for operation range |

See separate drawing for electrical data

Technical specifications				FHA100A + RZASG100MY1	FHA125A + RZASG125MY1	FHA140A + RZASG140MY1
Cooling capacity	Nom.	kW	9.50 (1)	12.1 (1)	13.4 (1)	
Heating capacity	Nom.	kW	10.8 (2)	13.5 (2)	15.5 (2)	
Space cooling	Energy efficiency class		A+	-	-	
	Capacity	P _{design}	kW	9.50	12.1	13.4
	SEER			5.83		5.88
	η _{s,c}		%	-	230	232
	Annual energy consumption		kWh/a	570	1,246	1,368
Space heating (Average climate)	Energy efficiency class		A	-	-	
	Capacity	P _{design}	kW	6.00	7.80	
	SCOP/A			3.91	3.83	3.81
	SCOP _{net} /A			3.91	3.83	3.81
	η _{s,h}		%	-	150	149
	Annual energy consumption		kWh/a	2,148	2,193	2,866
	Required back up heating cap at design conditions		kW		0.00	

2 Specifications

2 - 1 Specifications

2

Technical specifications				FHA100A + RZASG100MY1	FHA125A + RZASG125MY1	FHA140A + RZASG140MY1	
Space cooling	A Condi- tion (35°C -27/19)	Pdc	kW	9.50	12.10	13.40	
		EERd		3.20	2.63	2.77	
	B Condi- tion (30°C -27/19)	Power input	kW	2.97	4.60	4.84	
		Pdc	kW	7.00	8.92	9.88	
	C Condi- tion (25°C -27/19)	EERd		4.91	4.53	4.59	
		Power input	kW	1.43	1.97	2.15	
	D Condi- tion (20°C -27/19)	Pdc	kW	4.50	5.74	6.35	
		EERd		6.98	6.79	6.85	
		Power input	kW	0.64	0.85	0.93	
		EERd		8.87	9.62	9.50	
Space heating (Average climate)	TOL	Tol (temperature operating limit)	°C		-10		
		Pdh (declared heating cap)	kW		6.00	7.80	
		COPd (declared COP)			2.49	1.98	
		Power input	kW		2.41	3.95	
	TBivalent	Tbiv (bivalent temperature)	°C		-10		
		Pdh (declared heating cap)	kW		6.00	7.80	
		COPd (declared COP)			2.49	1.98	
		Power input	kW		2.41	3.95	
	A Con- dition (-7°C)	Pdh (declared heating cap)	kW	5.31	5.30	6.90	
		COPd (declared COP)		2.73	2.72	2.37	
	Space heating (Average climate)	A Con- dition (-7°C)	Power input	kW	1.94	1.95	2.91
		B Condi- tion (2°C)	Pdh (declared heating cap)	kW		3.23	4.20
			COPd (declared COP)		3.77	3.68	3.92
			Power input	kW	0.86	0.88	1.07
C Condi- tion (7°C)		Pdh (declared heating cap)	kW	2.18	2.19	3.45	
		COPd (declared COP)		4.96	4.84	4.95	
		Power input	kW	0.44	0.45	0.70	
D Con- dition (12°C)		Pdh (declared heating cap)	kW	2.57	2.58	4.05	
		COPd (declared COP)		6.14	6.00	6.07	
	Power input	kW	0.42	0.43	0.67		
Power consump- tion in other than active mode	Crank- case heater mode	Cooling PCK	kW		0.000		
		Heating PCK	kW		0.000		
	Off mode	Cooling POFF	kW		0.012		
		Heating POFF	kW		0.012		
	Standby mode	Cooling PSB	kW		0.012		
		Heating PSB	kW		0.012		
	Thermo- stat-off mode	Cooling PTO	kW		0.000		
		Heating PTO	kW		0.012		
Indication if the heater is equipped with a supplementary heater (pair application)			-		No		
Supplementary heater (pair application)	Back-up Heating elbu	kW	-		0.0		
Cooling	Cdc (Degradation cooling)			0.25			
Heating	Cdh (Degradation heating)			0.25			
Cooling function included				Yes			
Heating function included				Yes			
Average climate included				Yes			
Cold season included				No			
Warm season included				No			
Ecolabel logo				No			
(1)Nominal cooling capacities are based on: indoor temperature: 27°CDB, 19°CWB, outdoor temperature: 35°CDB, equivalent refrigerant piping: 5m, level difference: 0m.							
(2)Nominal heating capacities are based on: indoor temperature: 20°CDB, outdoor temperature: 7°CDB, 6°CWB, equivalent refrigerant piping: 5m, level difference: 0m.							
See separate drawing for operation range							
See separate drawing for electrical data							
Technical specifications				FUA100A + RZASG100MY1	FUA125A + RZASG125MY1		
Cooling capacity	Nom.	kW		9.50 (1)		12.1 (1)	
Heating capacity	Nom.	kW		10.8 (2)		13.5 (2)	

2 Specifications

2 - 1 Specifications

Technical specifications				FUA100A + RZASG100MY1	FUA125A + RZASG125MY1		
Space cooling	Energy efficiency class			A+	-		
	Capacity	Pdesign	kW	9.50	12.1		
	SEER			5.83	5.49		
	$\eta_{s,c}$		%	-	217		
Annual energy consumption			kWh/a	570	1,322		
Space heating (Average climate)	Energy efficiency class			A+	-		
	Capacity	Pdesign	kW	6.00			
	SCOP/A			4.01	3.84		
	SCOPnet/A			4.01	3.84		
	$\eta_{s,h}$		%	-	151		
	Annual energy consumption			kWh/a	2,095	2,188	
	Required back up heating cap at design conditions			kW	0.00		
Space cooling	A Condi- tion (35°C - 27/19)	Pdc	kW	9.50	12.10		
		EERd		3.20	2.35		
	B Condi- tion (30°C - 27/19)	Pdc	kW	7.00	8.92		
		EERd		4.81	4.24		
	C Condi- tion (25°C - 27/19)	Pdc	kW	4.50	5.74		
		EERd		7.04	6.48		
	D Condi- tion (20°C - 27/19)	Pdc	kW	3.10	3.14		
		EERd		8.98	9.22		
	Power input			kW	0.35	0.34	
	Space heating (Average climate)	TOL	Tol (temperature operating limit)			-10	
			Pdh (declared heating cap)	kW		6.00	
			COPd (declared COP)		2.56	2.52	
Power input			kW	2.35	2.38		
TBivalent		Tbiv (bivalent temperature)			-10		
		Pdh (declared heating cap)	kW		6.00		
		COPd (declared COP)		2.56	2.52		
		Power input	kW	2.35	2.38		
A Con- dition (-7°C)		Pdh (declared heating cap)		kW	5.31	5.30	
		COPd (declared COP)			2.79	2.76	
Space heating (Average climate)		A Con- dition (-7°C)	Power input		kW	1.90	1.92
			B Condi- tion (2°C)	Pdh (declared heating cap)		kW	
	COPd (declared COP)				3.87	3.70	
	Power input			kW	0.83	0.87	
	C Condi- tion (7°C)	Pdh (declared heating cap)		kW	2.19	2.21	
		COPd (declared COP)			5.10	4.81	
		Power input		kW	0.43	0.46	
	D Con- dition (12°C)	Pdh (declared heating cap)		kW	2.57	2.59	
		COPd (declared COP)			6.26	5.89	
		Power input		kW	0.41	0.44	
	Power consump- tion in other than active mode	Crank- case heater mode	Cooling	PCK	kW	0.000	
			Heating	PCK	kW	0.000	
Off mode		Cooling	POFF	kW	0.012		
		Heating	POFF	kW	0.012		
Standby mode		Cooling	PSB	kW	0.012		
		Heating	PSB	kW	0.012		
Thermo- stat-off mode		Cooling	PTO	kW	0.000		
		Heating	PTO	kW	0.012		
Indication if the heater is equipped with a supplementary heater (pair application)				-	No		
Supplementary heater (pair appli- cation)		Back-up capacity	Heating	elbu	kW	-	0.0
Cooling	Cdc (Degradation cooling)			0.25			
Heating	Cdh (Degradation heating)			0.25			
Cooling function included				Yes			
Heating function included				Yes			
Average climate included				Yes			
Cold season included				No			
Warm season included				No			
Ecolabel logo				No			

2 Specifications

2 - 1 Specifications

(1)Nominal cooling capacities are based on: indoor temperature: 27°CDB, 19°CWB, outdoor temperature: 35°CDB, equivalent refrigerant piping: 5m, level difference: 0m. |

(2)Nominal heating capacities are based on: indoor temperature: 20°CDB, outdoor temperature: 7°CDB, 6°CWB, equivalent refrigerant piping: 5m, level difference: 0m. |

See separate drawing for operation range |

See separate drawing for electrical data

2

Technical specifications				FAA100B + RZASG100MY1		
Cooling capacity	Nom.	kW		9.50 (1)		
Heating capacity	Nom.	kW		10.8 (2)		
Space cooling	Energy efficiency class			A+		
	Capacity	Pdesign	kW	9.50		
	SEER			5.83		
	Annual energy consumption		kWh/a	570		
Space heating (Average climate)	Energy efficiency class			A		
	Capacity	Pdesign	kW	6.00		
	SCOP/A			3.85		
	SCOPnet/A			3.85		
	Annual energy consumption		kWh/a	2,182		
	Required back up heating cap at design conditions		kW	0.00		
Space cooling	A Condi- tion (35°C - 27/19)	Pdc	kW	9.50		
		EERd		2.70		
	B Condi- tion (30°C - 27/19)	Pdc	kW	7.00		
		EERd		4.87		
	C Condi- tion (25°C - 27/19)	Pdc	kW	4.50		
		EERd		6.85		
	D Condi- tion (20°C - 27/19)	Pdc	kW	3.00		
		EERd		10.23		
	Space heating (Average climate)	TOL	Tol (temperature operating limit)		°C	-10
			Pdh (declared heating cap)	kW	6.00	
			COPd (declared COP)		2.31	
		TBivalent	Tbiv (bivalent temperature)		°C	-10
Pdh (declared heating cap)			kW	6.00		
COPd (declared COP)				2.31		
A Con- dition (-7°C)		Pdh (declared heating cap)	kW	5.31		
		COPd (declared COP)		2.55		
		Power input	kW	2.08		
B Condi- tion (2°C)		Pdh (declared heating cap)	kW	3.23		
		COPd (declared COP)		3.68		
		Power input	kW	0.88		
C Condi- tion (7°C)		Pdh (declared heating cap)	kW	2.12		
		COPd (declared COP)		5.09		
		Power input	kW	0.42		
D Con- dition (12°C)		Pdh (declared heating cap)	kW	2.52		
		COPd (declared COP)		6.53		
		Power input	kW	0.39		
Power consump- tion in other than active mode	Crank- case heater mode	Cooling	PCK	kW	0.000	
		Heating	PCK	kW	0.000	
	Off mode	Cooling	POFF	kW	0.012	
		Heating	POFF	kW	0.012	
	Standby mode	Cooling	PSB	kW	0.012	
		Heating	PSB	kW	0.012	
	Thermo- stat-off mode	Cooling	PTO	kW	0.000	
		Heating	PTO	kW	0.012	
	Cooling	Cdc (Degradation cooling)			0.25	
	Heating	Cdh (Degradation heating)			0.25	
Cooling function included				Yes		
Heating function included				Yes		
Average climate included				Yes		
Cold season included				No		
Warm season included				No		
Ecolabel logo				No		

(1)Nominal cooling capacities are based on: indoor temperature: 27°CDB, 19°CWB, outdoor temperature: 35°CDB, equivalent refrigerant piping: 5m, level difference: 0m. |

(2)Nominal heating capacities are based on: indoor temperature: 20°CDB, outdoor temperature: 7°CDB, 6°CWB, equivalent refrigerant piping: 5m, level difference: 0m. |

See separate drawing for operation range |

See separate drawing for electrical data

2 Specifications

2 - 1 Specifications

Technical specifications				FVA100A + RZASG100MY1	FVA125A + RZASG125MY1	FVA140A + RZASG140MY1	
Cooling capacity	Nom.	kW		9.50 (1)	12.1 (1)	13.4 (1)	
Heating capacity	Nom.	kW		10.8 (2)	13.5 (2)	15.5 (2)	
Space cooling	Energy efficiency class			A+	-	-	
	Capacity	Pdesign	kW	9.50	12.1	13.4	
	SEER			5.72	5.52	5.63	
	ηs,c		%	-	218	222	
	Annual energy consumption		kWh/a	581	1,314	1,428	
Space heating (Average climate)	Energy efficiency class			A	-	-	
	Capacity	Pdesign	kW		6.00	7.80	
	SCOP/A			3.83	3.64	3.81	
	SCOPnet/A			3.83	3.64	3.81	
	ηs,h		%	-	143	149	
	Annual energy consumption		kWh/a	2,193	2,308	2,866	
	Required back up heating cap at design conditions		kW		0.00		
Space cooling	A Condi- tion (35°C	Pdc	kW	9.50	12.10	13.40	
		EERd		3.20	2.47	2.62	
	-27/19)	Power input	kW	2.97	4.90	5.12	
	B Condi- tion (30°C	Pdc	kW	7.00	8.92	9.88	
		EERd		5.01	4.31	4.52	
	-27/19)	Power input	kW	1.40	2.07	2.19	
	C Condi- tion (25°C	Pdc	kW	4.50	5.74	6.35	
		EERd		6.78	6.26	6.51	
	-27/19)	Power input	kW	0.66	0.92	0.98	
	D Condi- tion (20°C	Pdc	kW	3.00	3.07	3.76	
		EERd		8.25	9.54	8.88	
	-27/19)	Power input	kW	0.36	0.32	0.42	
Space heating (Average climate)	TOL	Tol (temperature operating limit)			-10		
		Pdh (declared heating cap)	kW		6.00	7.80	
		COPd (declared COP)		2.46	2.37	1.99	
		Power input	kW	2.44	2.53	3.93	
	TBivalent	Tbiv (bivalent temperature)			-10		
		Pdh (declared heating cap)	kW		6.00	7.80	
		COPd (declared COP)		2.46	2.37	1.99	
		Power input	kW	2.44	2.53	3.93	
	A Con- dition (-7°C)	Pdh (declared heating cap)	kW	5.31	5.30	6.90	
		COPd (declared COP)		2.70	2.60	2.38	
	Space heating (Average climate)	A Con- dition (-7°C)	Power input	kW	1.97	2.04	2.90
B Condi- tion (2°C		Pdh (declared heating cap)	kW		3.23	4.20	
		COPd (declared COP)		3.72	3.51	3.90	
		Power input	kW	0.87	0.92	1.08	
C Condi- tion (7°C		Pdh (declared heating cap)	kW	2.20	2.19	3.47	
		COPd (declared COP)		4.81	4.57	4.99	
		Power input	kW	0.46	0.48	0.70	
D Con- dition (12°C		Pdh (declared heating cap)	kW	2.58	2.57	4.07	
		COPd (declared COP)		5.82	5.60	6.10	
	Power input	kW	0.44	0.46	0.67		
Power consump- tion in other than active mode	Crank- case heater mode	Cooling	PCK	kW	0.000		
		Heating	PCK	kW	0.000		
	Off mode	Cooling	POFF	kW		0.012	
		Heating	POFF	kW		0.012	
	Standby mode	Cooling	PSB	kW		0.012	
		Heating	PSB	kW		0.012	
	Thermo- stat-off mode	Cooling	PTO	kW		0.000	
		Heating	PTO	kW		0.012	
	Indication if the heater is equipped with a supplementary heater (pair application)				-	No	
	Supplementary heater (pair application)	Back-up capacity	Heating elbu	kW	-	0.0	
Cooling	Cdc (Degradation cooling)				0.25		
Heating	Cdh (Degradation heating)				0.25		
Cooling function included					Yes		
Heating function included					Yes		
Average climate included					Yes		

2 Specifications

2 - 1 Specifications

2

Technical specifications	FVA100A + RZASG100MY1	FVA125A + RZASG125MY1	FVA140A + RZASG140MY1
Cold season included		No	
Warm season included		No	
Ecolabel logo		No	

(1)Nominal cooling capacities are based on: indoor temperature: 27°CDB, 19°CWB, outdoor temperature: 35°CDB, equivalent refrigerant piping: 5m, level difference: 0m. |

(2)Nominal heating capacities are based on: indoor temperature: 20°CDB, outdoor temperature: 7°CDB, 6°CWB, equivalent refrigerant piping: 5m, level difference: 0m. |

See separate drawing for operation range |

See separate drawing for electrical data

4 Options

4 - 1 Options

4

AZAS-MV1
AZAS-MY1
RZAG-MV1
RZAG-MY1
RZASG-MV1
RZASG-MY1

Available options for RZAG models

Option	Option kit			
	RZAG71M7V1B RZAG71M7Y1B	RZAG100M7V1B RZAG100M7Y1B	RZAG125M7V1B RZAG125M7Y1B	RZAG140M7V1B RZAG140M7Y1B
Bottom plate heater	EKBPH140L7			
Refrigerant branch piping	KHRQ(M)58T			
	Twin	KHRQ(M)58H		
	Triple	-	KHRQ(M)58T	
Demand adaptor kit	Double twin	-	KHRQ(M)58T (3x)	
	SB.KRP58M52			

Available options for RZASG models

Option	Option kit			
	RZASG71M2V1B	RZASG100M7V1B RZASG100M7Y1B	RZASG125M7V1B RZASG125M7Y1B	RZASG140M7V1B RZASG140M7Y1B
Bottom plate heater	-			
Refrigerant branch piping	KHRQ(M)58T			
	Twin	KHRQ(M)58H		
	Triple	-	KHRQ(M)58T	
Demand adaptor kit	Double twin	-	KHRQ(M)58T (3x)	
	SB.KRP58M52			

3D108867

6 Capacity tables

6 - 1 Cooling/Heating Capacity Tables

6

RZASG100MV1

RZASG100MY1

Cooling

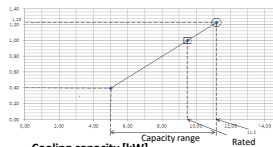

Heating

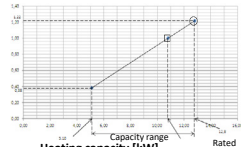

Symbols

- AFR: Air flow rate [m³/min]
- BF: Bypass factor
- EWB: Entering wet-bulb temperature (°C WB)
- EDB: Entering dry-bulb temperature (°C DB)
- TC: Maximum total cooling/heating capacity [kW]
- SHC: Sensible heat capacity [kW]
- CPI: Coefficient of the power input
- Pl: Power input [kW]

Outdoor temperature [°C DB]	Cooling						Heating					
	TC	SHC	CPI	TC	SHC	CPI	TC	SHC	CPI	TC	SHC	CPI
15.0	11.6	11.6	1.00	11.4	11.4	1.00	11.6	11.6	1.00	11.6	11.6	1.00
18.0	11.6	11.6	1.00	11.4	11.4	1.00	11.6	11.6	1.00	11.6	11.6	1.00
20.0	11.6	11.6	1.00	11.4	11.4	1.00	11.6	11.6	1.00	11.6	11.6	1.00
22.0	11.6	11.6	1.00	11.4	11.4	1.00	11.6	11.6	1.00	11.6	11.6	1.00
24.0	11.6	11.6	1.00	11.4	11.4	1.00	11.6	11.6	1.00	11.6	11.6	1.00

Outdoor temperature [°C DB]	Cooling						Heating					
	TC	SHC	CPI	TC	SHC	CPI	TC	SHC	CPI	TC	SHC	CPI
-15.0	11.6	11.6	1.00	11.4	11.4	1.00	11.6	11.6	1.00	11.6	11.6	1.00
-10.0	11.6	11.6	1.00	11.4	11.4	1.00	11.6	11.6	1.00	11.6	11.6	1.00
0.0	11.6	11.6	1.00	11.4	11.4	1.00	11.6	11.6	1.00	11.6	11.6	1.00
5.0	11.6	11.6	1.00	11.4	11.4	1.00	11.6	11.6	1.00	11.6	11.6	1.00
10.0	11.6	11.6	1.00	11.4	11.4	1.00	11.6	11.6	1.00	11.6	11.6	1.00

Notes

- The ratings shown are net capacities which include a deduction for indoor fan motor heat.
- = Maximum at standard conditions
□ = Rated capacity and rated coefficient of the power input
The maximum capacity is not guaranteed except at standard conditions.
- SHC is based on indoor units -EWB & EDB.
SHC for other dry-bulb temperatures = SHC + SHC*
SHC* = SHC correction for other dry-bulb temperatures
= 0.02 x AFR (m³/min) x (1-BF) x (DB* - EDB)
- The capacities are based on the following conditions:
Outdoor air: 85% RH
However, the outdoor ambient condition of the rated capacity during heating operation is 7°C DB / 6°C WB.
Corresponding refrigerant piping length: 5.0 m
Level difference: 0 m
- CPI is a percentage value compared to the rated value which is 1.00.
- The error rate for this value is less than 5% and depends on the indoor unit type.
- The heating performance takes into account the drop that occurs during defrost operation.
- The air flow rate and bypass factor are mentioned in the table.
- The rated power input for each model is mentioned in the table below.

Pair	FCAG100B	FAA100B	FVA100A	FHA100A	FUA100A	FBA100A
AFR (BF)	22.8 (0.17)	26.0 (0.10)	28.0 (0.20)	28.0 (0.09)	31.0 (0.20)	29.0 (0.03)

Twin	FCAG50B X 2	FHA50A9 X 2	FFA50A9 X 2	FDXM50F9 X 2	FBA50A9 X 2	FNA50A9 X 2
AFR (BF)	12.6 x 2 (0.22 x 2)	15.0 x 2 (0.18 x 2)	12.0 x 2 (0.16 x 2)	15.8 x 2 (0.11 x 2)	15.0 x 2 (0.13 x 2)	16.0 x 2 (0.11 x 2)

Triple	FCAG35B X 3	FHA35A9 X 3	FFA35A9 X 3	FDXM35F9 X 3	FBA35A9 x 3	FNA35A9 X 3
AFR (BF)	12.5 x 3 (0.4 x 3)	14.0 x 3 (0.17 x 3)	10.0 x 3 (0.25 x 3)	8.7 x 3 (0.17 x 3)	15.0 x 3 (0.08 x 3)	8.7 x 3 (0.17 x 3)

Pair	FCAG100B	FAA100B	FVA100A	FHA100A	FUA100A	FBA100A
Cooling	2,92	3,52	2,97	2,97	2,97	2,97
Heating	2,92	2,85	2,43	2,86	2,85	2,26

Twin	FCAG50B X 2	FHA50A9 X 2	FFA50A9 X 2	FDXM50F9 X 2	FBA50A9 X 2	FNA50A9 X 2
Cooling	2,57	2,97	3,39	2,44	2,86	2,44
Heating	2,37	2,23	2,33	2,41	2,19	2,23

Triple	FCAG35B X 3	FHA35A9 X 3	FFA35A9 X 3	FDXM35F9 X 3	FBA35A9 x 3	FNA35A9 X 3
Cooling	2,32	2,16	2,71	2,57	2,65	2,57
Heating	2,84	2,77	2,14	2,26	1,99	2,31

3D112145E

RZASG125MV1

RZASG125MY1

Cooling

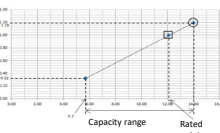

Heating

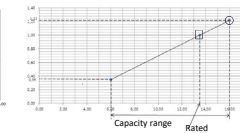

Symbols

- AFR: Air flow rate [m³/min]
- BF: Bypass factor
- EWB: Entering wet-bulb temperature (°C WB)
- EDB: Entering dry-bulb temperature (°C DB)
- TC: Maximum total cooling/heating capacity [kW]
- SHC: Sensible heat capacity [kW]
- CPI: Coefficient of the power input
- Pl: Power input [kW]

Outdoor temperature [°C DB]	Cooling						Heating					
	TC	SHC	CPI	TC	SHC	CPI	TC	SHC	CPI	TC	SHC	CPI
15.0	13.8	13.8	1.00	13.6	13.6	1.00	13.8	13.8	1.00	13.8	13.8	1.00
18.0	13.8	13.8	1.00	13.6	13.6	1.00	13.8	13.8	1.00	13.8	13.8	1.00
20.0	13.8	13.8	1.00	13.6	13.6	1.00	13.8	13.8	1.00	13.8	13.8	1.00
22.0	13.8	13.8	1.00	13.6	13.6	1.00	13.8	13.8	1.00	13.8	13.8	1.00
24.0	13.8	13.8	1.00	13.6	13.6	1.00	13.8	13.8	1.00	13.8	13.8	1.00

Outdoor temperature [°C DB]	Cooling						Heating					
	TC	SHC	CPI	TC	SHC	CPI	TC	SHC	CPI	TC	SHC	CPI
-15.0	13.8	13.8	1.00	13.6	13.6	1.00	13.8	13.8	1.00	13.8	13.8	1.00
-10.0	13.8	13.8	1.00	13.6	13.6	1.00	13.8	13.8	1.00	13.8	13.8	1.00
0.0	13.8	13.8	1.00	13.6	13.6	1.00	13.8	13.8	1.00	13.8	13.8	1.00
5.0	13.8	13.8	1.00	13.6	13.6	1.00	13.8	13.8	1.00	13.8	13.8	1.00
10.0	13.8	13.8	1.00	13.6	13.6	1.00	13.8	13.8	1.00	13.8	13.8	1.00

Notes

- The ratings shown are net capacities which include a deduction for indoor fan motor heat.
- = Maximum at standard conditions
□ = Rated capacity and rated coefficient of the power input
The maximum capacity is not guaranteed except at standard conditions.
- SHC is based on indoor units EWB & EDB.
SHC for other dry-bulb temperatures = SHC + SHC*
SHC* = SHC correction for other dry-bulb temperatures
= 0.02 x AFR (m³/min) x (1-BF) x (DB* - EDB)
- The capacities are based on the following conditions:
Outdoor air: 85% RH
However, the outdoor ambient condition of the rated capacity during heating operation is 7°C DB / 6°C WB.
Corresponding refrigerant piping length: 5.0 m
Level difference: 0 m
- CPI is a percentage value compared to the rated value which is 1.00.
- The error rate for this value is less than 5% and depends on the indoor unit type.
- The heating performance takes into account the drop that occurs during defrost operation.
- The air flow rate and bypass factor are mentioned in the table.
- The rated power input for each model is mentioned in the table below.

Pair	FCAG125B	FDA125A	FVA125A	FHA125A	FUA125A	FBA125A
AFR (BF)	26.0 (0.21)	30.0 (0.16)	28.0 (0.16)	31.0 (0.14)	32.5 (0.19)	34.0 (0.06)

Twin	FCAG60B X 2	FHA60A X 2	FFA60A X 2	FDXM60F3 X 2	FBA60A X 2	FNA60A X 2
AFR (BF)	13.6 x 2 (0.2 x 2)	19.5 x 2 (0.20 x 2)	14.5 x 2 (0.11 x 2)	16.0 x 2 (0.12 x 2)	18.0 x 2 (0.18 x 2)	16.0 x 2 (0.12 x 2)

Triple	FCAG50B X 3	FHA50A X 3	FFA50A X 3	FDXM50F3 X 3	FBA50A X 3	FNA50A X 3
AFR (BF)	12.6 x 3 (0.22 x 3)	15.0 x 3 (0.18 x 3)	12.0 x 3 (0.16 x 3)	15.8 x 3 (0.11 x 3)	15.0 x 3 (0.13 x 3)	16.0 x 3 (0.11 x 3)

Double twin	FCAG35B X 4	FHA35A X 4	FFA35A X 4	FDXM35F3 X 4	FBA35A X 4	FNA35A X 4
AFR (BF)	12.5 x 4 (0.4 x 4)	14.0 x 4 (0.17 x 4)	10.0 x 4 (0.25 x 4)	8.7 x 4 (0.17 x 4)	15.0 x 4 (0.08 x 4)	8.7 x 4 (0.17 x 4)

Pair	FCAG125B	FDA125A	FVA125A	FHA125A	FUA125A	FBA125A
Cooling	4,95	4,75	4,90	4,60	5,15	4,63
Heating	3,15	3,31	3,64	3,49	3,38	3,37

Twin	FCAG60B X 2	FHA60A X 2	FFA60A X 2	FDXM60F3 X 2	FBA60A X 2	FNA60A X 2
Cooling	4,15	6,21	6,01	3,87	4,28	3,87
Heating	3,31	3,13	3,19	3,47	2,99	3,47

Triple	FCAG50B X 3	FHA50A X 3	FFA50A X 3	FDXM50F3 X 3	FBA50A X 3	FNA50A X 3
Cooling	3,74	4,42	4,65	3,37	4,08	3,37
Heating	2,87	2,87	2,90	3,13	2,89	3,13

Double twin	FCAG35B X 4	FHA35A X 4	FFA35A X 4	FDXM35F3 X 4	FBA35A X 4	FNA35A X 4
Cooling	3,34	2,89	4,00	3,80	3,83	3,80
Heating	2,73	2,81	2,88	3,15	2,90	3,13

3D112146B

6 Capacity tables

6 - 1 Cooling/Heating Capacity Tables

RZASG140MV1

RZASG140MY1

Cooling

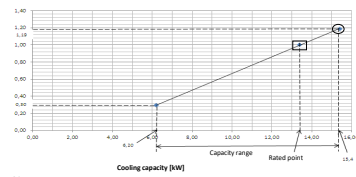

Heating

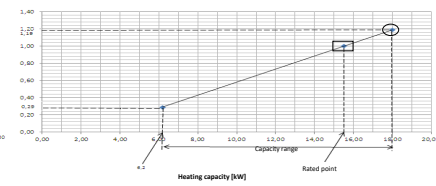

Cooling

Indoor		Outdoor temperature [°C DB]											
		25			30			35			40		
[°C WB]	[°C DB]	TC	SHC	CPI	TC	SHC	CPI	TC	SHC	CPI	TC	SHC	CPI
16.0	22	15.5	10.47	0.98	14.9	10.25	1.08	14.4	10.03	1.18	13.9	9.69	1.28
18.0	25	16.2	10.55	0.98	15.6	10.21	1.09	15.1	10.01	1.19	14.5	9.71	1.30
19.0	27	16.6	10.43	0.99	16.0	10.18	1.09	15.4	9.98	1.19	14.8	9.76	1.30
19.5	27	16.7	10.49	0.99	16.1	10.16	1.10	15.6	10.00	1.19	15.0	9.66	1.30
22.0	30	17.6	10.37	0.99	17.0	10.16	1.10	16.4	9.89	1.21	15.3	9.60	1.31
24.0	32	18.4	10.20	1.00	17.7	10.00	1.11	17.0	9.67	1.22	16.4	9.47	1.32

Heating

Indoor		Outdoor temperature [°C DB]											
		-15		-10		-5		0		6		10	
[°C WB]	[°C DB]	TC	CPI	TC	CPI	TC	CPI	TC	CPI	TC	CPI	TC	CPI
16	11.6	0.91	12.7	0.97	13.6	1.00	13.9	1.03	18.0	1.09	19.4	1.16	
18	11.6	0.95	12.7	1.00	13.6	1.04	13.9	1.07	18.0	1.14	19.4	1.21	
20	11.6	0.99	12.7	1.05	13.5	1.09	13.9	1.11	18.0	1.19	19.4	1.25	
21	11.5	1.00	12.7	1.06	13.5	1.11	13.9	1.13	18.0	1.21	19.4	1.28	
22	11.5	1.02	12.7	1.08	13.5	1.12	13.9	1.16	18.0	1.24	19.4	1.30	
24	11.5	1.07	12.6	1.12	13.5	1.17	13.9	1.20	18.0	1.29	19.4	1.35	

Notes

- The ratings shown are net capacities which include a deduction for indoor fan motor heat
- = Maximum at standard conditions
□ = Rated capacity and rated coefficient of the power input
The maximum capacity is not guaranteed except at standard conditions.
- SHC is based on indoor units: -EWB & EDB.
-SHC for other dry-bulb temperatures = -SHC + SHC*.
SHC* = -SHC correction for other dry-bulb temperatures
= 0.02 x AFR (m³/min) x (1-BF) x (DB* - EDB)
- The capacities are based on the following conditions:
Outdoor air: -85% RH;
However, the outdoor ambient condition of the rated capacity during heating operation is -7°C DB / 6°C WB.
Corresponding refrigerant piping length: -5.0 m
Level difference: -0 m
- CPI is a percentage value compared to the rated value which is -1.00.
- The error rate for this value is less than -5% and depends on the indoor unit type.
- The heating performance takes into account the drop that occurs during defrost operation.
- The air flow rate and bypass factor are mentioned in the table.
- The rated power input for each model is mentioned in the table below.

Pair	FCAG140B	FVA140A	FHA140A	FBA140A
AFR (BF)	26.0 (0.23)	30.0 (0.18)	34.0 (0.17)	34.0 (0.06)

Pair	FCAG140B	FVA140A	FHA140A	FBA140A
Cooling	4.88	5.12	4.84	4.76
Heating	4.16	4.42	3.60	3.89

Twin	FCAG71B X 2	FAA71B X 2	FHA71A X 2	FUA71A X 2	FBA71A X 2	FVA71A X 2
AFR (BF)	15.3 x 2 (0.14 x 2)	18.0 x 2 (0.16 x 2)	20.5 x 2 (0.13 x 2)	23.0 x 2 (0.24 x 2)	18.0 x 2 (0.13 x 2)	18.0 x 2 (0.16 x 2)

Twin	FCAG71B X 2	FAA71B X 2	FHA71A X 2	FUA71A X 2	FBA71A X 2	FVA71A X 2
Cooling	3.87	4.14	3.91	3.62	3.82	4.52
Heating	3.82	3.97	3.63	3.50	3.72	4.23

Triple	FCAG50B X 3	FHA50A X 3	FFA50A X 3	FDXM50F3 X 3	FBA50A X 3	FNA50A X 3
AFR (BF)	12.6 x 3 (0.22 x 3)	15.0 x 3 (0.18 x 3)	12.0 x 3 (0.16 x 3)	15.8 x 3 (0.11 x 3)	15.0 x 3 (0.13 x 3)	16.0 x 3 (0.11 x 3)

Triple	FCAG50B X 3	FHA50A X 3	FFA50A X 3	FDXM50F3 X 3	FBA50A X 3	FNA50A X 3
Cooling	3.39	4.14	4.32	2.86	3.91	2.86
Heating	3.48	3.51	3.59	3.91	3.51	3.91

Double	FCAG35B X 4	FHA35A X 4	FFA35A X 4	FDXM35F3 X 4	FBA35A X 4	FNA35A X 4
AFR (BF)	12.5 x 4 (0.4 x 4)	14.0 x 4 (0.20 x 4)	10.0 x 4 (0.25 x 4)	8.7 x 4 (0.17 x 4)	15.0 x 4 (0.08 x 4)	8.7 x 4 (0.17 x 4)

Double twin	FCAG35B X 4	FHA35A X 4	FFA35A X 4	FDXM35F3 X 4	FBA35A X 4	FNA35A X 4
Cooling	3.05	3.06	3.66	3.65	3.51	3.65
Heating	4.12	3.47	3.44	3.96	4.19	3.96

Symbols

- AFR: Air flow rate [m³/min]
- BF: Bypass factor
- EWB: Entering wet-bulb temperature [°C WB]
- EDB: Entering dry-bulb temperature [°C DB]
- TC: Maximum total cooling/heating capacity [kW]
- SHC: Sensible heat capacity [kW]
- CPI: Coefficient of the power input
- PI: Power input [kW]
compressor + indoor and outdoor fan motors

3D112147C

6 Capacity tables

6 - 2 Capacity Correction Factor

6

RZASG-MV1

RZASG-MY1

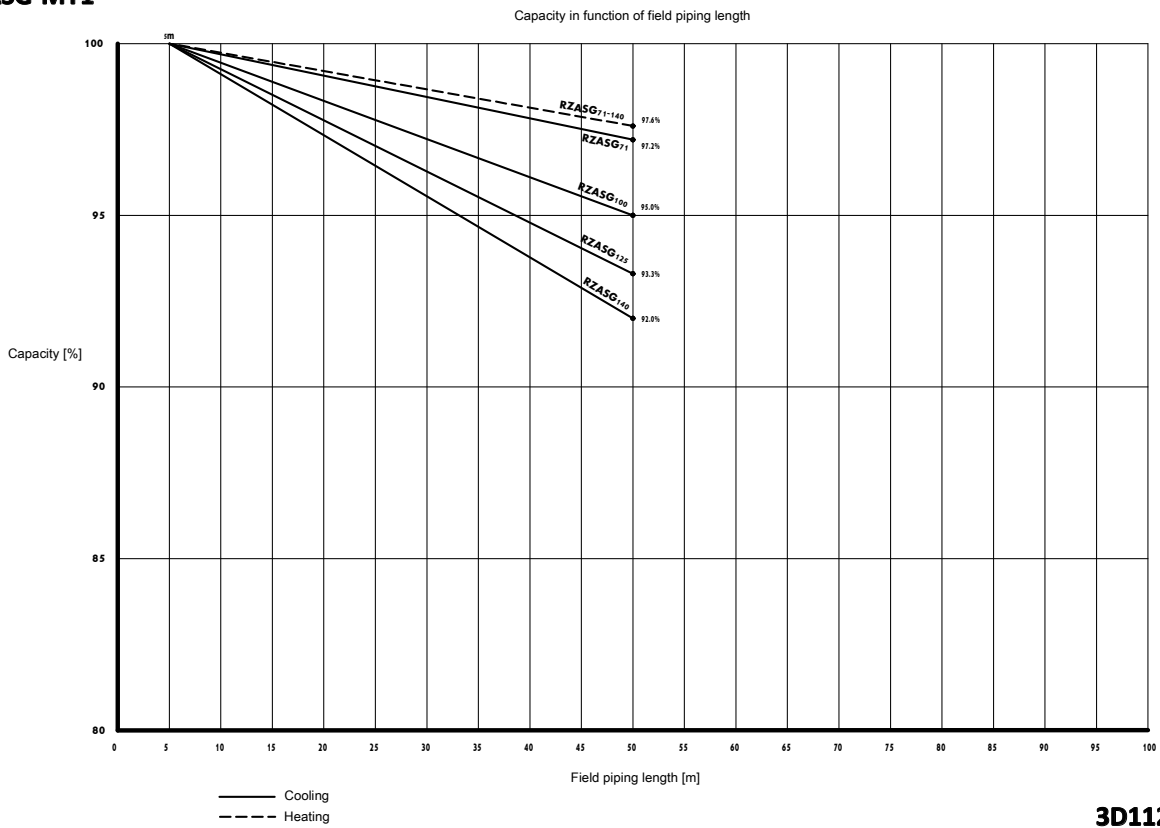

7 Dimensional drawings

7 - 1 Dimensional Drawings

AZAS100-140MV1
 AZAS-MY1
 RZAG71MV1
 RZAG71MY1
 RZASG100-140MV1
 RZASG-MY1

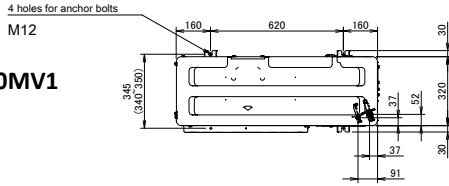

Model	AA	AB
RZAG71* / RZASG100-125* / AZAS100-125*	331	337
RZASG140* / AZAS140*	414	420

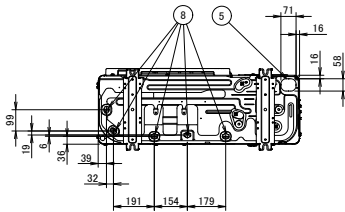
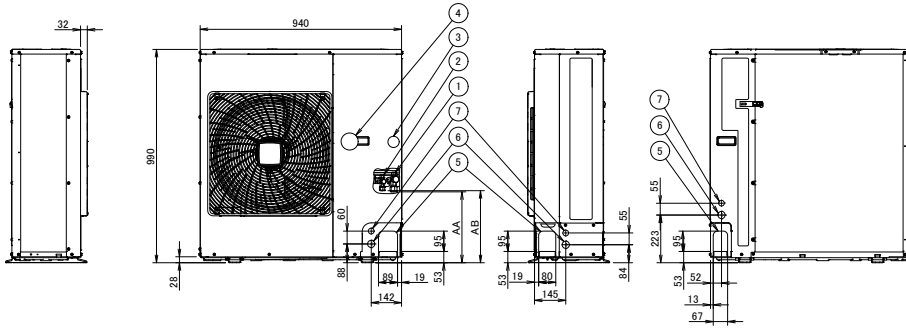

- ① Gas pipe connection Ø15.9 flare
- ② Liquid pipe connection Ø9.5 flare
- ③ Service port (in the unit)
- ④ Electronic connection and grounding terminal M5 (in the switch box)
- ⑤ Refrigerant piping intake
- ⑥ Power supply wiring intake (knockout hole Ø34)
- ⑦ Control wiring intake (knockout hole Ø27)
- ⑧ Drain outlet

3D110011

8 Centre of gravity

8 - 1 Centre of Gravity

8

- AZAS100-140MV1
- AZAS-MY1
- RZAG71MV1
- RZAG71MY1
- RZASG100-140MV1
- RZASG-MY1

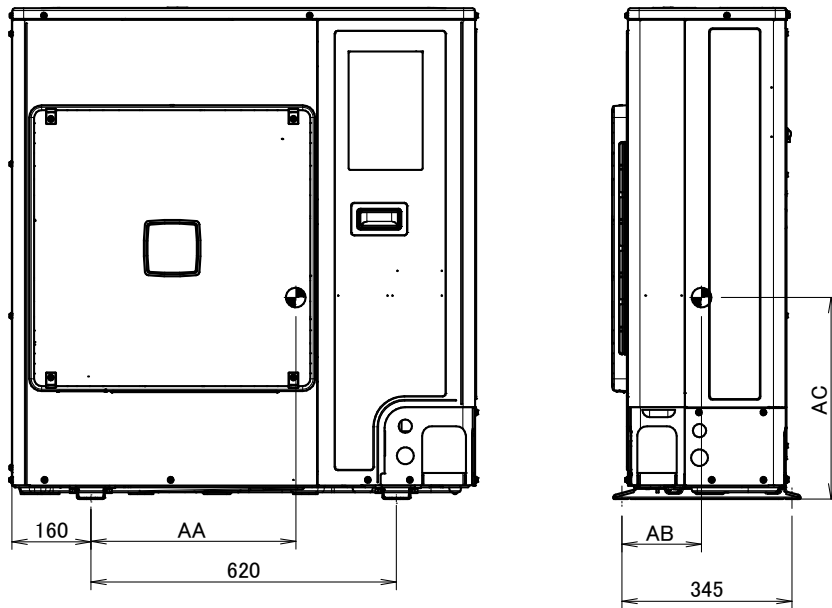

Model	AA	AB	AC
RZAG71M7V*	414	163	407
RZAG71M7Y*	432	137	407
RZASG100-125M7V* / AZAS100-125M7V*	425	181	422
RZASG100-125M7Y* / AZAS100-125M7Y*	414	156	417
RZASG140M7V* / AZAS140M7V*	414	161	423
RZASG140M7Y* / AZAS140M7Y*	416	151	418

4D110025

9 Piping diagrams

9 - 1 Piping Diagrams

AZAS-MV1
 AZAS-MY1
 RZAG-MV1
 RZAG-MY1
 RZASG-MV1
 RZASG-MY1

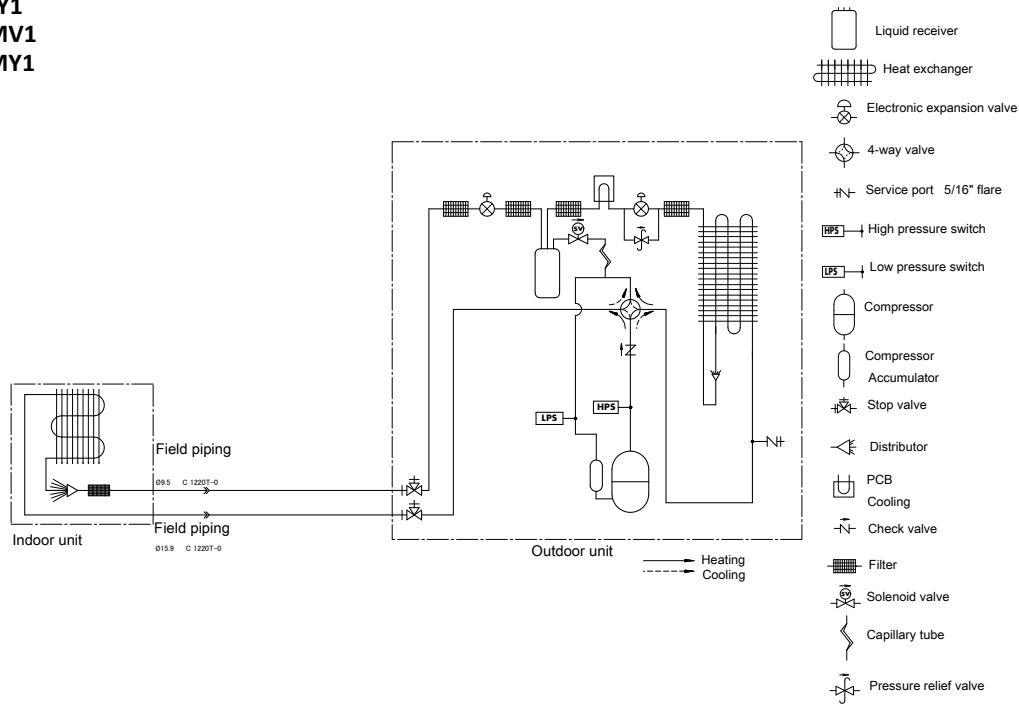

Notes

- The pipes between the branch and the indoor units should have the same size as the indoor connections.

3D108855A

9 Piping diagrams

9 - 2 Piping Diagram Twin Application

RZAG-MV1
RZAG-MY1
RZASG-MV1
RZASG-MY1

9

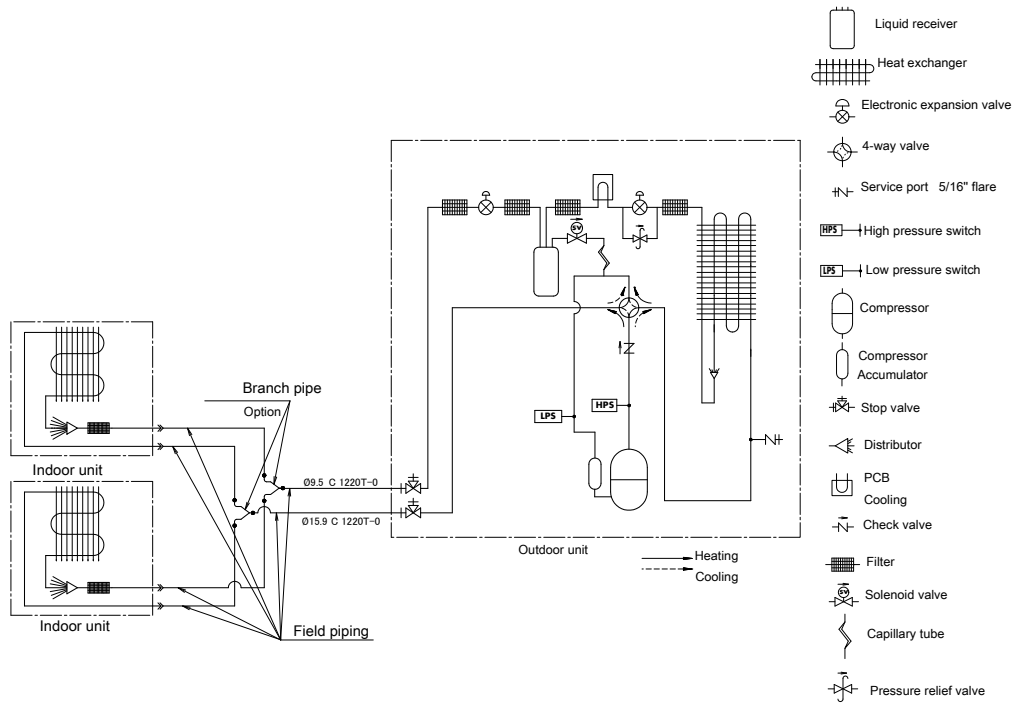

Notes

- 1. The pipes between the branch and the indoor units should have the same size as the indoor connections.

3D108856A

9 Piping diagrams

9 - 3 Piping Diagram Triple Application

RZAG100-140MV1
 RZAG100-140MY1
 RZASG100-140MV1
 RZASG-MY1

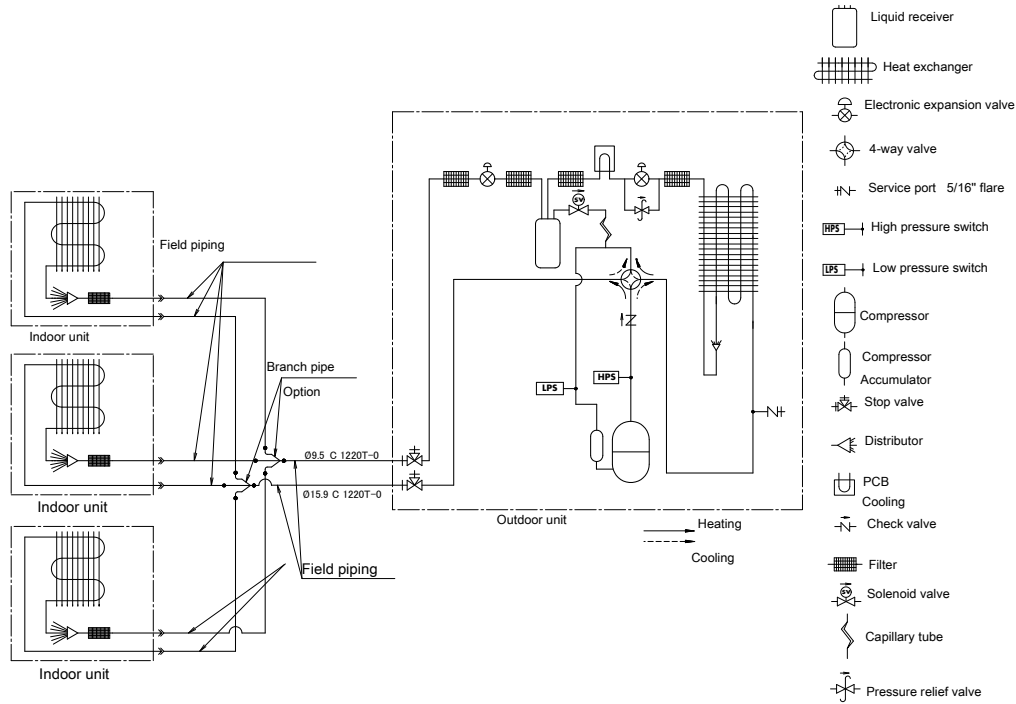

Notes

1. The pipes between the branch and the indoor units should have the same size as the indoor connections.

3D108857A

9 Piping diagrams

9 - 4 Piping Diagram Double Twin Application

9

RZAG125-140MV1
 RZAG125-140MY1
 RZASG125-140MV1
 RZASG125-140MY1

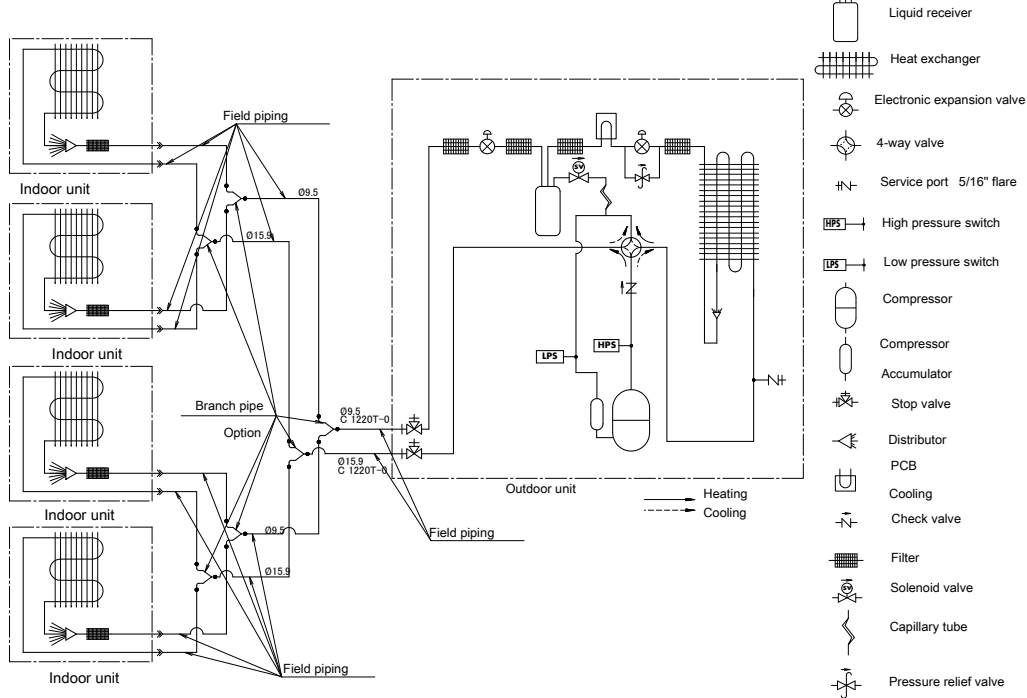

Notes

1. The pipes between the branch and the indoor units should have the same size as the indoor connections.

3D108858A

10 Wiring diagrams

10 - 1 Wiring Diagrams - Three Phase

RZAG-MY1, RZASG-MY1, AZAS-MY1

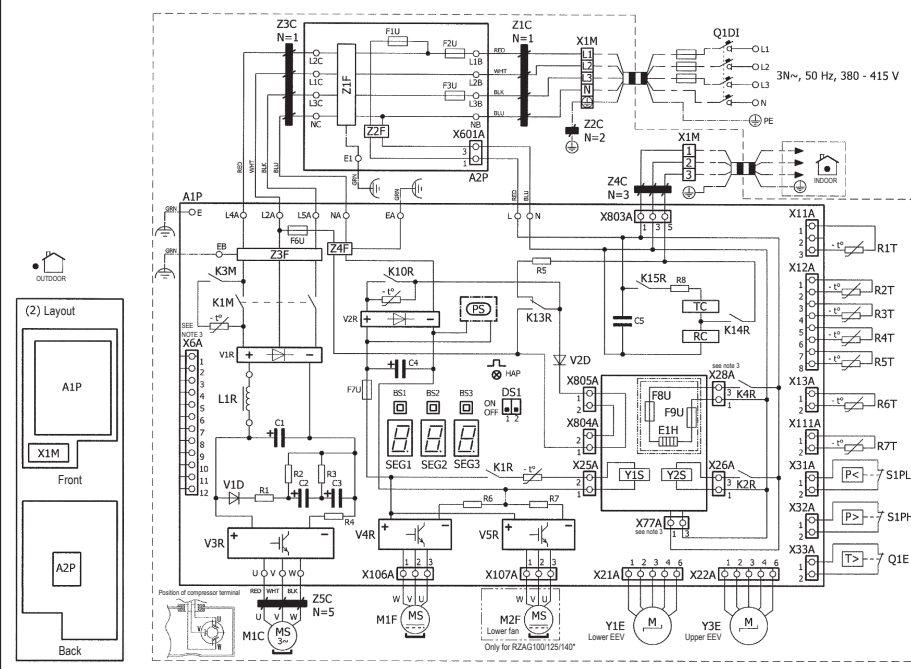

Part n°	Description
A1P	Printed circuit board (main)
A2P	Printed circuit board (noise filter)
BS1-BS3 (A1P)	Push-button switch
C1-CS (A1P)	Capacitor
DS1 (A1P)	Dipswitch
E1H	Bottom plate heater
F1U (A2P)	Fuse T 6.3 A 250 V
F2U, F3U (A2P)	Fuse T 30 A 500 V
F6U (A1P)	Fuse T 6.3 A 250 V
F7U (A1P)	Fuse T 5 A 250 V
F8U, F9U	Fuse T 1 A 250 V
HAP (A1P)	Light-emitting diode (service monitor is green)
K1M, K3M (A1P)	Magnetic contactor
K1R (A1P)	Magnetic relay (Y1S)
K2R (A1P)	Magnetic relay (Y2S)
K4R (A1P)	Magnetic relay (E1H)
K10R K13R-K15R (A1P)	Magnetic relay
L1R	Reactor
M1C	Compressor motor
M1F, M2F	Fan motor
PS (A1P)	Switching power supply
Q1DI	Earth leakage circuit breaker (30mA)
Q1E	Overload protection
R1-R8 (A1P)	Resistor
R1T	Thermistor (air)
R2T	Thermistor (discharge)
R3T	Thermistor (suction)
R4T	Thermistor (heat exchanger)
R5T	Thermistor (heat exchanger middle)
R6T	Thermistor (liquid)
R7T	Thermistor (fin)
RC (A1P)	Signal receiver circuit
S1PH	High pressure switch
S1PL	Low pressure switch
SEG1-SEG3 (A1P)	7-segment display
TC (A1P)	Signal transmission circuit
V1D, V2D (A1P)	Diode module
V3R-V5R (A1P)	IGBT power module
X1M	Terminal strip
Y1E, Y3E	Electronic expansion valve
Y1S, Y2S	Solenoid valve (4-way valve)
Z1C-Z3C	Noise filter (ferrite core)
Z1F-Z4F (A1P-A2P)	Noise filter
L'A, L'B, NA, NBE*, U, V, W, X'A (A1P, A2P)	Connector

- NOTES**
1. Refer to the wiring diagram sticker (on the back of the front plate) for how to use the BS1-BS3 and DS1 switches.
 2. When operating, do not short-circuit protection device(s) S1PH, S1PL and Q1E.
 3. Refer to the combination table and the option manual for how to connect the wiring to X6A, X28A and X77A.
 4. Colours: BLK: Black, RED: Red, BLU: Blue, WHT: White, GRN: Green.

4D109448

11 Sound data

11 - 1 Sound Power Spectrum

11

AZAS100MV1
 AZAS100MY1
 RZASG100MV1
 RZASG100MY1

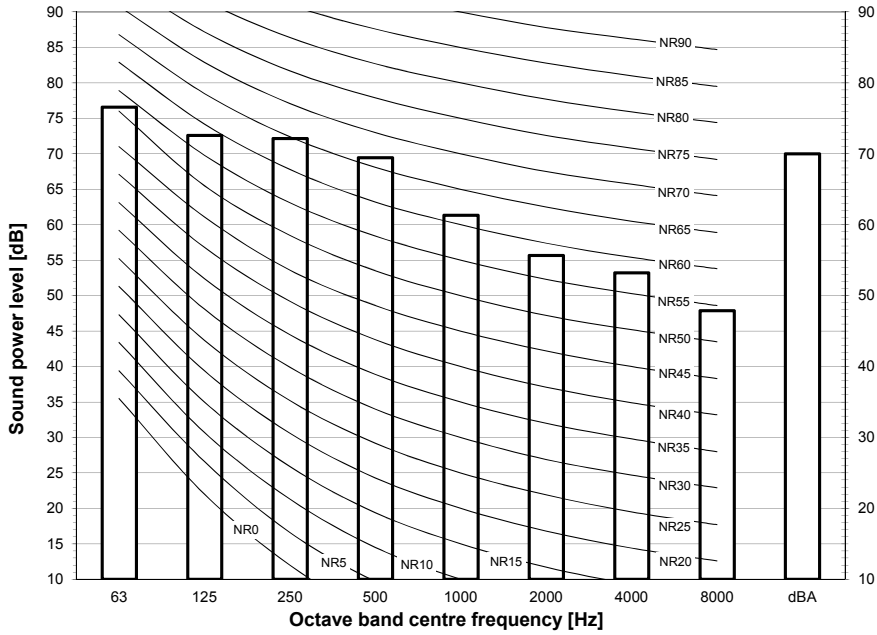

Notes

- dBA = A-weighted sound power level (A scale according to IEC).
- Reference acoustic intensity 0dB = 10E-6μW/m²
- Measured according to ISO 3744

3D110038

AZAS125MV1
 AZAS125MY1
 RZASG125MV1
 RZASG125MY1

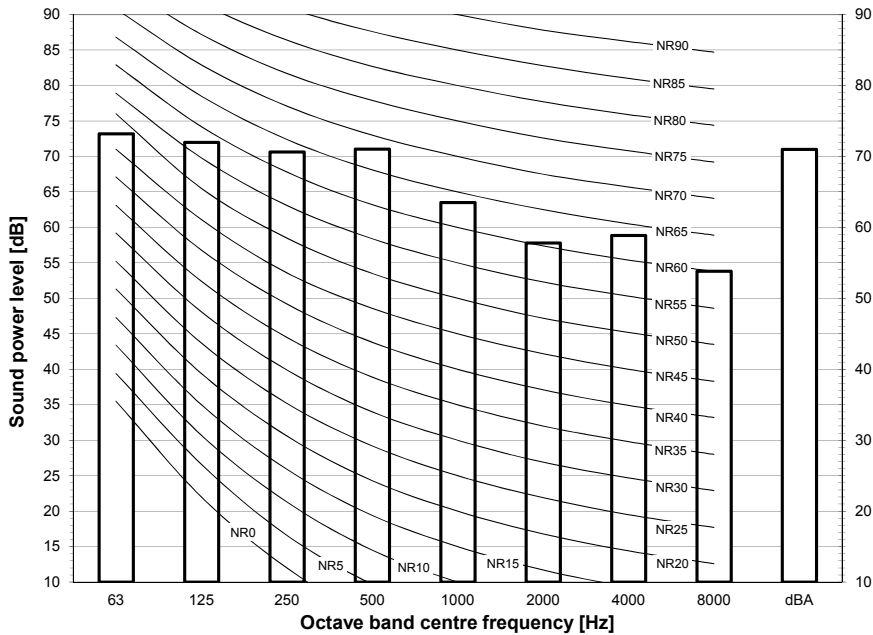

Notes

- dBA = A-weighted sound power level (A scale according to IEC).
- Reference acoustic intensity 0dB = 10E-6μW/m²
- Measured according to ISO 3744

3D110039

11 Sound data

11 - 1 Sound Power Spectrum

AZAS140MV1
 AZAS140MY1
 RZASG140MV1
 RZASG140MY1

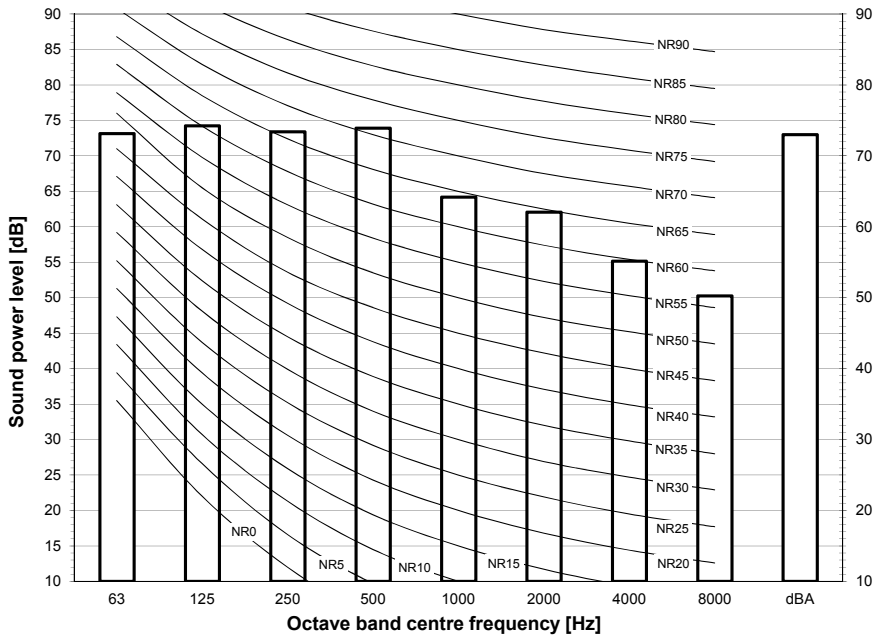

Notes
 - dBA = A-weighted sound power level (A scale according to IEC).
 - Reference acoustic intensity 0dB = 10E-6μW/m²
 - Measured according to ISO 3744

3D110040

11 Sound data

11 - 2 Sound Pressure Spectrum - Cooling

11

AZAS100MV1
 AZAS100MY1
 RZASG100MV1
 RZASG100MY1

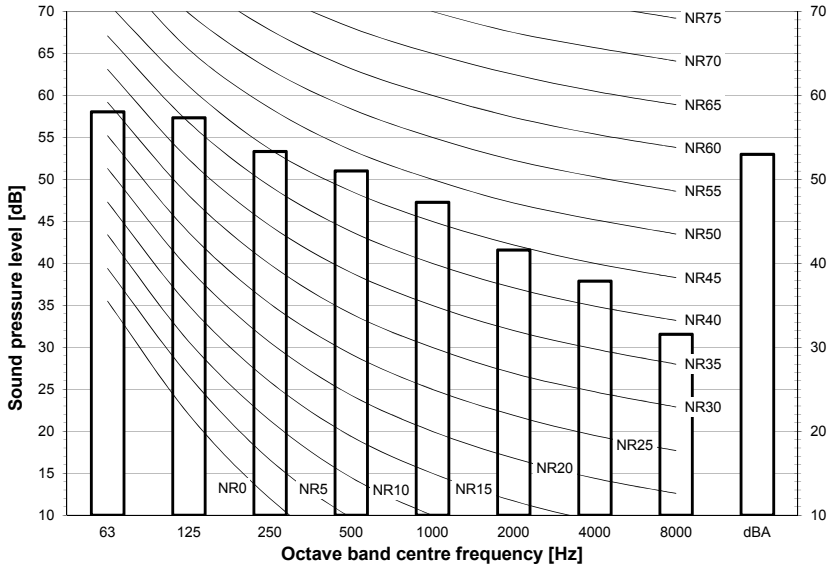

Notes

- Data is valid at free field condition.
- Data is valid at nominal operation condition.
- dBA = A-weighted sound pressure level (A scale according to IEC).
- Reference acoustic pressure 0 dB = 20 μPa

3D110050

AZAS125MV1
 AZAS125MY1
 RZASG125MV1
 RZASG125MY1

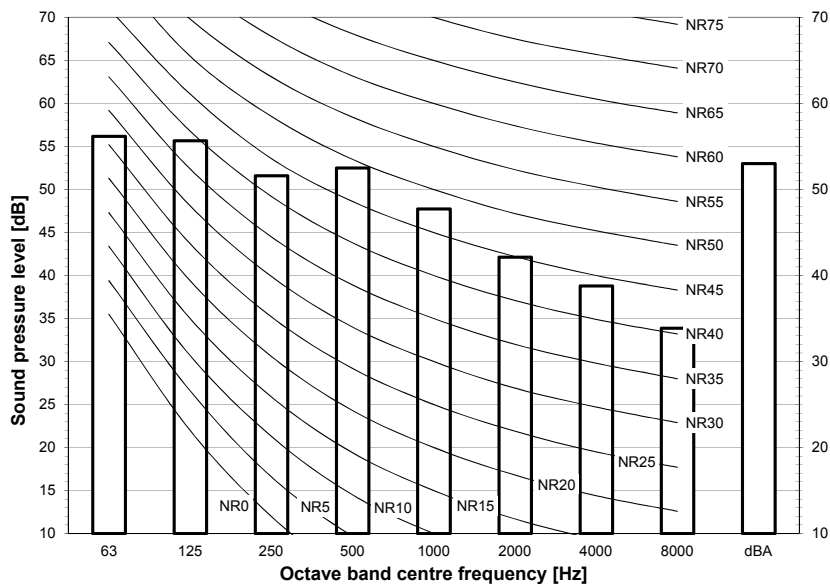

Notes

- Data is valid at free field condition.
- Data is valid at nominal operation condition.
- dBA = A-weighted sound pressure level (A scale according to IEC).
- Reference acoustic pressure 0 dB = 20 μPa

3D110051

11 Sound data

11 - 2 Sound Pressure Spectrum - Cooling

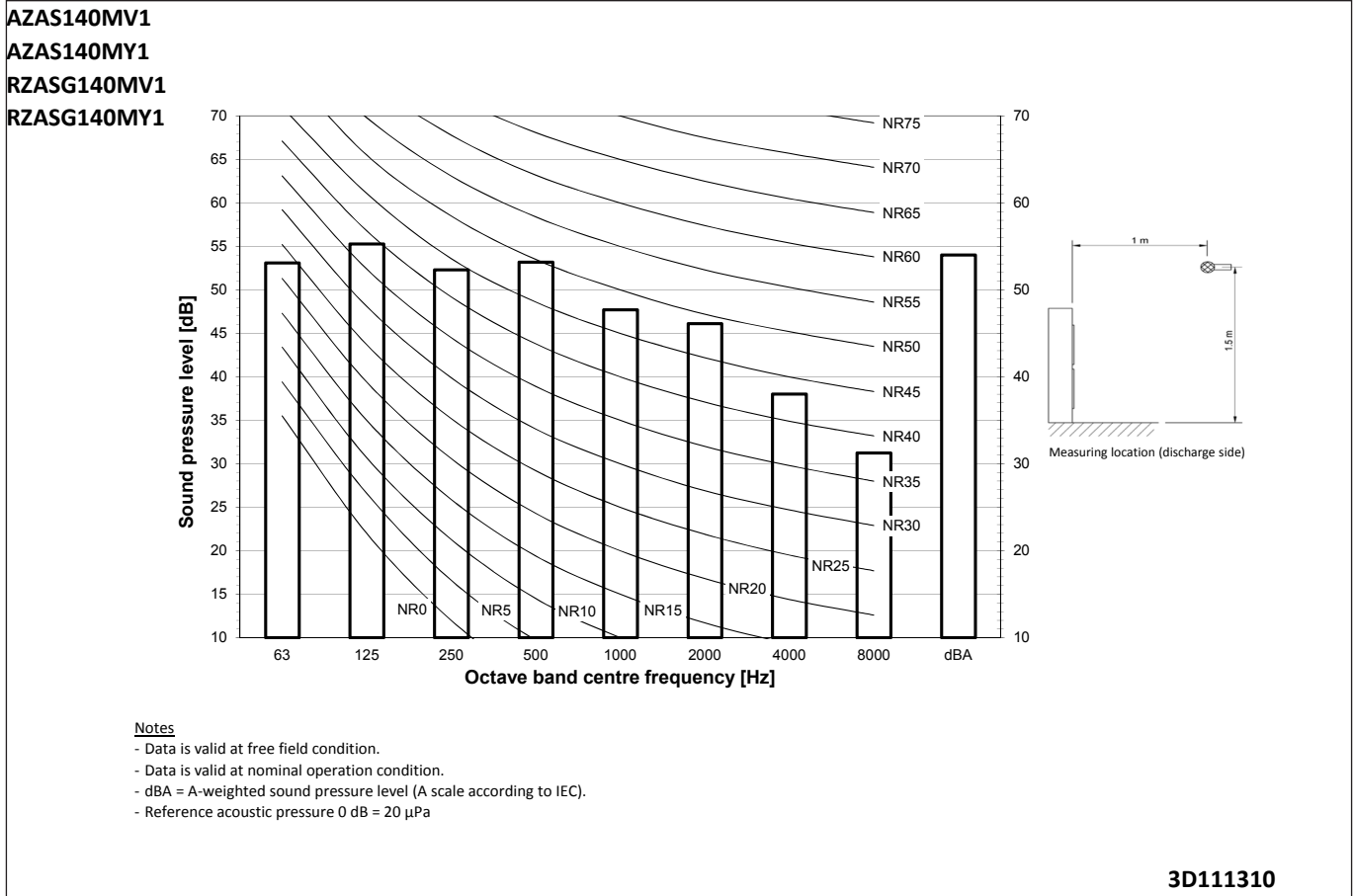

11 Sound data

11 - 3 Sound Pressure Spectrum - Heating

11

AZAS100MV1
 AZAS100MY1
 RZASG100MV1
 RZASG100MY1

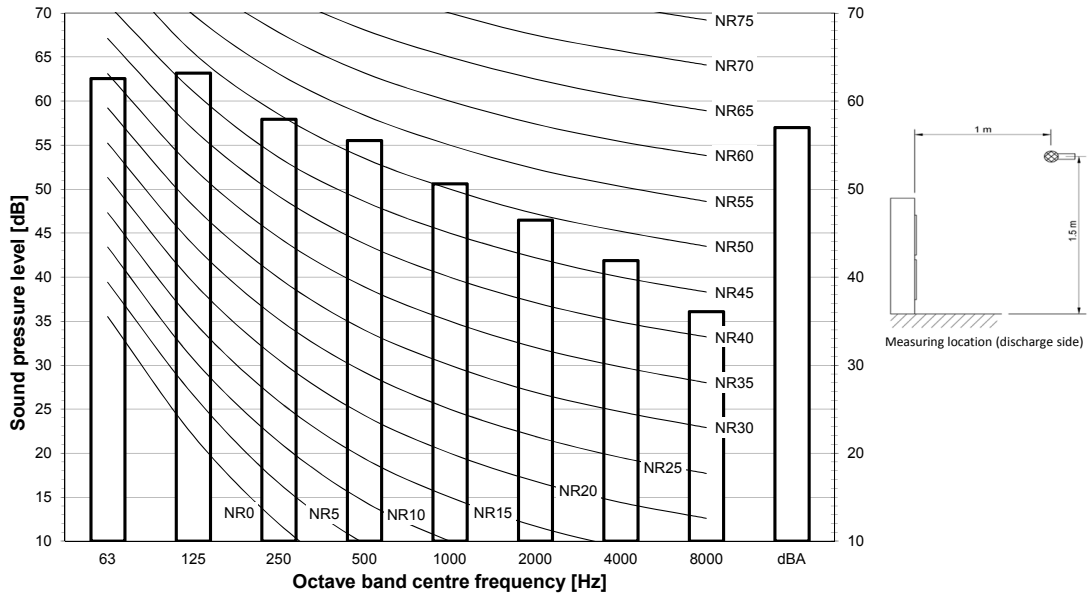

Notes

- Data is valid at free field condition.
- Data is valid at nominal operation condition.
- dBA = A-weighted sound pressure level (A scale according to IEC).
- Reference acoustic pressure 0 dB = 20 µPa

3D111294

AZAS125MV1
 AZAS125MY1
 RZASG125MV1
 RZASG125MY1

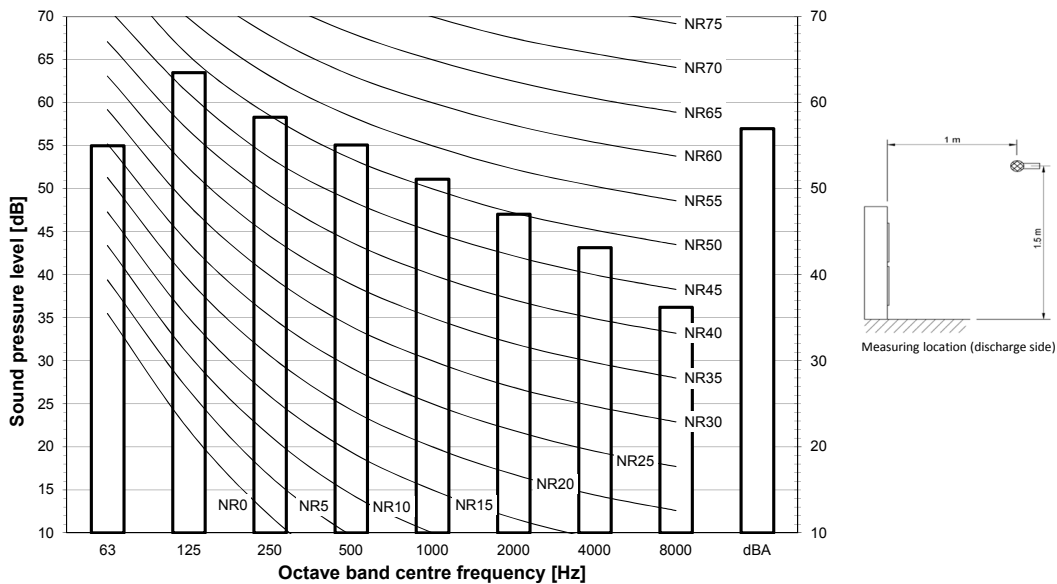

Notes

- Data is valid at free field condition.
- Data is valid at nominal operation condition.
- dBA = A-weighted sound pressure level (A scale according to IEC).
- Reference acoustic pressure 0 dB = 20 µPa

3D111295

11 Sound data

11 - 3 Sound Pressure Spectrum - Heating

AZAS140MV1
 AZAS140MY1
 RZASG140MV1
 RZASG140MY1

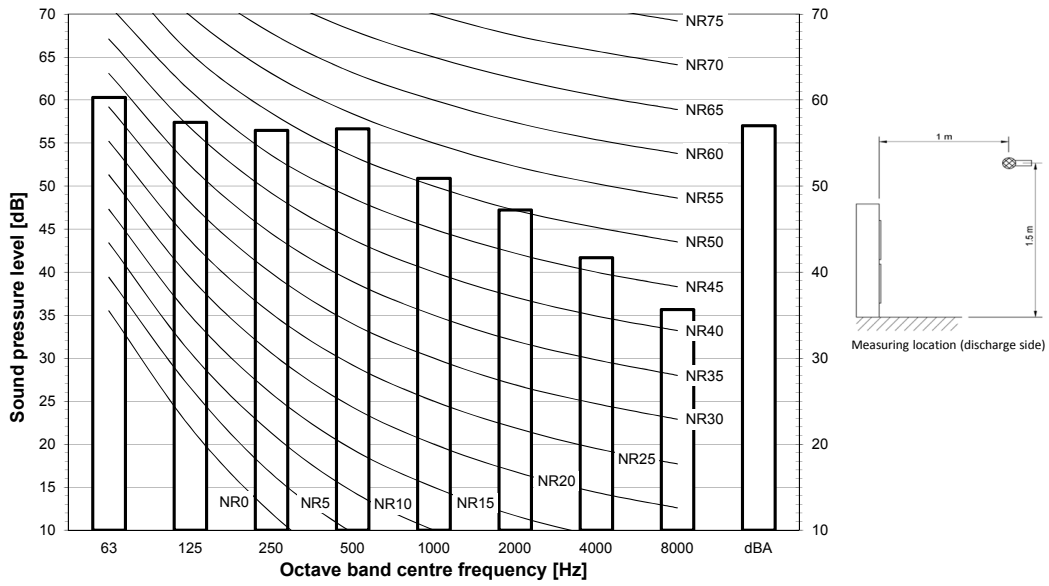

- Notes**
- Data is valid at free field condition.
 - Data is valid at nominal operation condition.
 - dBA = A-weighted sound pressure level (A scale according to IEC).
 - Reference acoustic pressure 0 dB = 20 μPa

3D111296

11 Sound data

11 - 4 Sound Pressure Spectrum Quiet Mode

11

AZAS100MV1
 AZAS100MY1
 RZASG100MV1
 RZASG100MY1

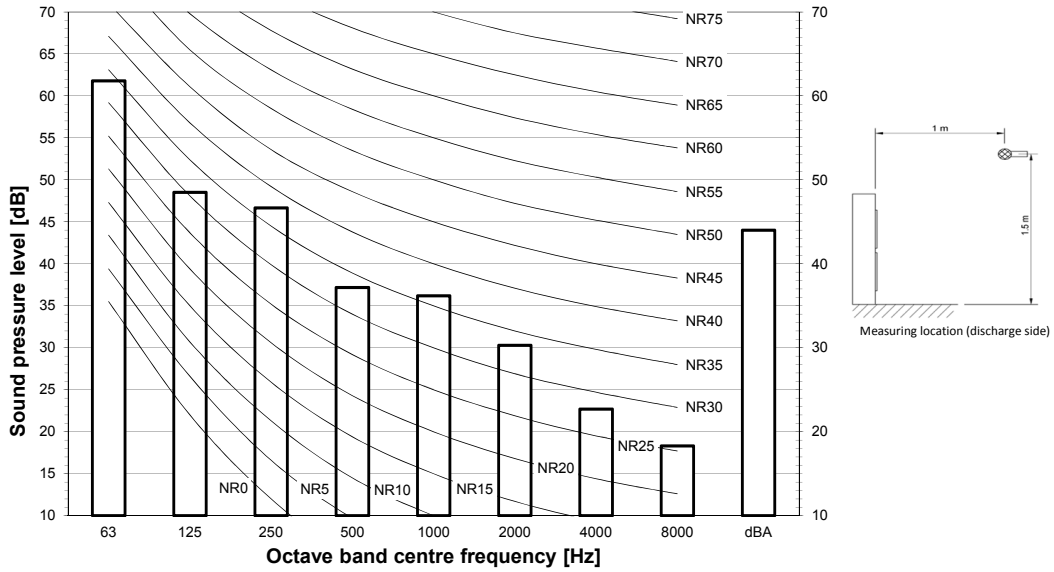

- Notes**
- Data is valid at free field condition.
 - Data is valid at nominal operation condition.
 - dBA = A-weighted sound pressure level (A scale according to IEC).
 - Reference acoustic pressure 0 dB = 20 μPa

3D111316

AZAS125MV1
 AZAS125MY1
 RZASG125MV1
 RZASG125MY1

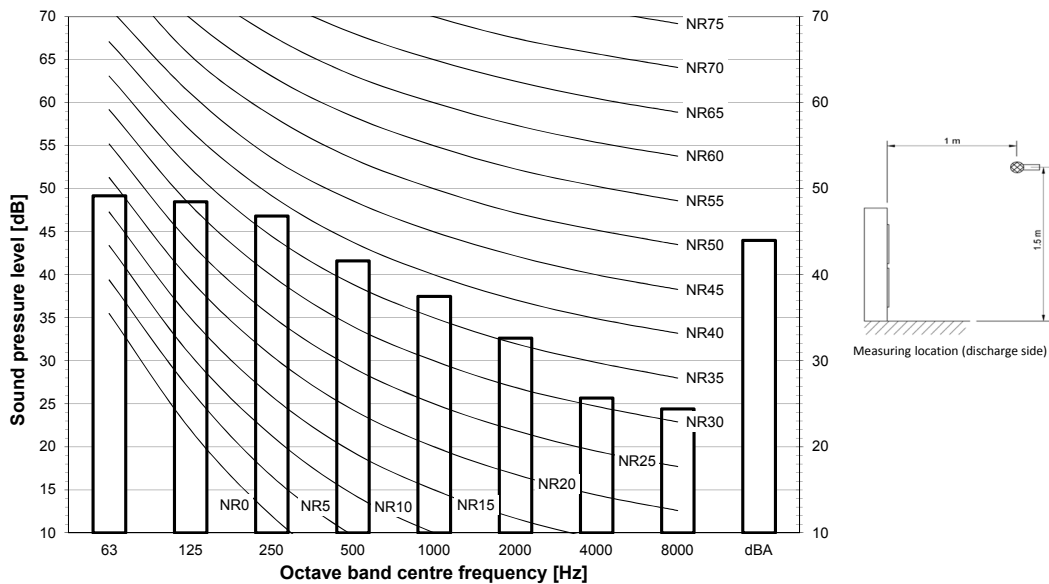

- Notes**
- Data is valid at free field condition.
 - Data is valid at nominal operation condition.
 - dBA = A-weighted sound pressure level (A scale according to IEC).
 - Reference acoustic pressure 0 dB = 20 μPa

3D111317

11 Sound data

11 - 4 Sound Pressure Spectrum Quiet Mode

AZAS140MV1
 AZAS140MY1
 RZASG140MV1
 RZASG140MY1

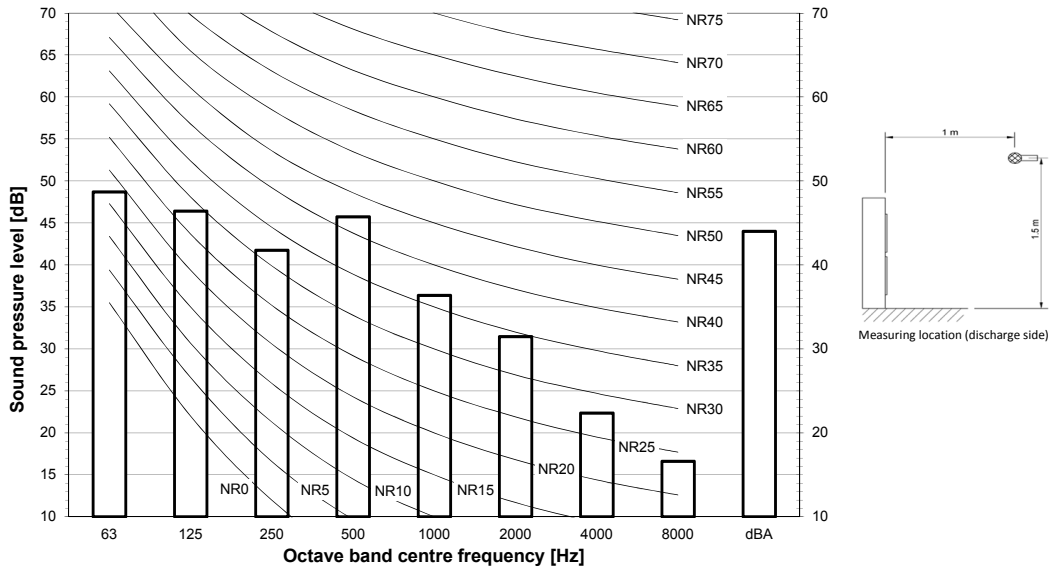

- Notes**
- Data is valid at free field condition.
 - Data is valid at nominal operation condition.
 - dBA = A-weighted sound pressure level (A scale according to IEC).
 - Reference acoustic pressure 0 dB = 20 μPa

3D111318

12 Installation

12 - 1 Installation Method

12

RZAG-MV1
RZAG-MY1
RZASG-MV1
RZASG-MY1
AZAS-MV1
AZAS-MY1

Installation service space

The measure of these values is "mm".

(A) When there are obstacles on suction sides.

● No obstacle above

- ① Stand-alone installation
 - Obstacle on the suction side only

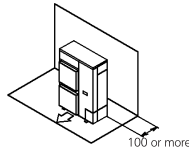

- Obstacle on both sides and suction side, too

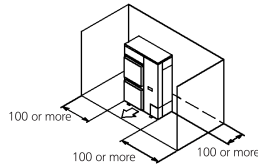

- ② Series installation (2 or more) (Note 1)
 - Obstacle on the suction side and both sides

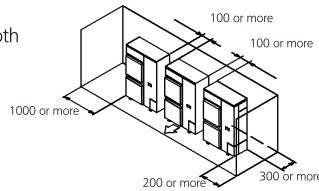

● Obstacle above, too.

- ① Stand-alone installation
 - Obstacle on the suction side, too

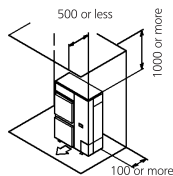

- Obstacle on both sides and suction side, too

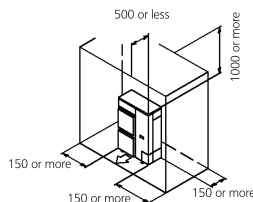

- ② Series installation (2 or more) (Note 1)
 - Obstacle on the suction side and both sides

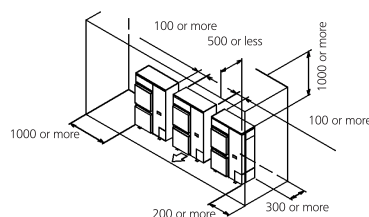

(B) When there are obstacles on discharge sides.

● No obstacle above

- ① Stand-alone installation
 - Obstacle on the discharge side only

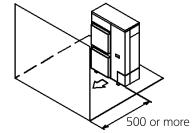

- ② Series installation (2 or more) (Note 1)
 - Obstacle on the discharge side only

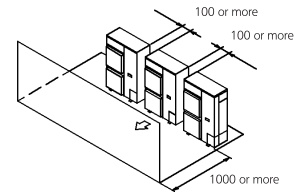

● Obstacle above, too

- ① Stand-alone installation
 - Obstacle on the discharge side only, too

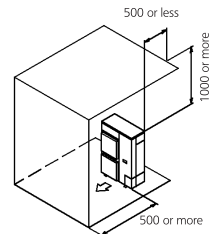

- ② Series installation (2 or more) (Note 1)
 - Obstacle on the discharge side

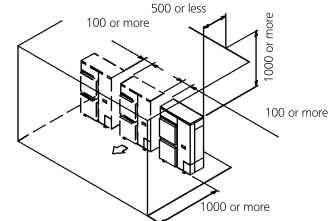

(C) When there are obstacles on both suction and discharge sides.:

Pattern 1

When the obstacles on the discharge side is higher than the unit. (L>H)
(There is no limit for the height of obstructions on the suction side.)

● No obstacle above

- ① Stand-alone installation
 - No obstacle above

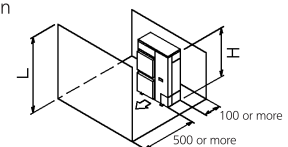

- ② Series installation (2 or more) (Note 1)
 - No obstacle above

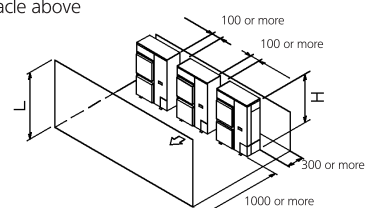

3D069554

12 Installation

12 - 1 Installation Method

RZAG-MV1
 RZAG-MY1
 RZASG-MV1
 RZASG-MY1
 AZAS-MV1
 AZAS-MY1

● **Obstacle above, too**

- ① Stand-alone installation (Note 2)
 - When there are obstacles on suction, discharge and top sides.

The relations between H, A and L are as follows.

	L	A
$L \leq H$	$L \leq 1/2 H$	750 or more
	$1/2 H < L \leq H$	1000 or more
$L > H$	Set the stand as : $L \leq H$ Refer to the column of $L \leq H$ for A	

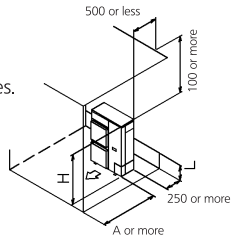

- ② Series installation (2 or more) (Note 1, 2)
 - When there are obstacles on suction, discharge and top sides.

The relations between H, A and L are as follows.

	L	A
$L \leq H$	$L \leq 1/2 H$	1000 or more
	$1/2 H < L \leq H$	1250 or more
$L > H$	Set the stand as : $L \leq H$ Refer to the column of $L \leq H$ for A	

Limit of series installation is 2 units.

Pattern 2

When the obstacle on the discharge side is lower than the unit ($L \leq H$) (There is no limit for the height of obstructions on the suction side.)

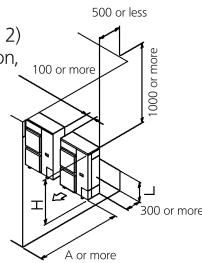

● **No obstacle above**

- ① Stand-alone installation
 - No obstacle above

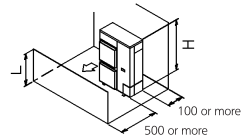

- ② Series installation (2 or more) (Note 1, 2)
 - When there are obstacles on both suction and discharge sides.

The relations between H, A and L are as follows.

	L	A
$L \leq H$	$L \leq 1/2 H$	250 or more
	$1/2 H < L \leq H$	300 or more

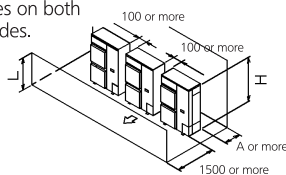

● **obstacle above**

- ① Stand-alone installation (Note 2)
 - When there are obstacles on suction, discharge and top sides.

The relations between H, A and L are as follows.

	L	A
$L \leq H$	$L \leq 1/2 H$	100 or more
	$1/2 H < L \leq H$	200 or more
$L > H$	Set the stand as : $L \leq H$ Refer to the column of $L \leq H$ for A	

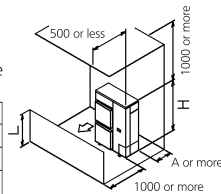

- ② Series installation (2 or more) (Note 1, 2)

- When there are obstacles on suction, discharge and top sides.

The relations between H, A and L are as follows.

	L	A
$L \leq H$	$L \leq 1/2 H$	250 or more
	$1/2 H < L \leq H$	300 or more
$L > H$	Set the stand as : $L \leq H$ Refer to the column of $L \leq H$ for A	

Limit of series installation is 2 units.

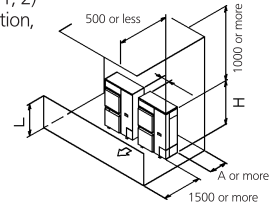

(D) Double-decker installation

- ① Obstacle on the discharge side. (1)
 - Do not exceed two levels for stacked installation.
 - Install a roof cover similar to A (field supply), as outdoor units with downward drainage are prone to dripping and freezing.
 - Install the upper-level outdoor unit so that its bottom plate is a sufficient height above the roof cover. This is to prevent the buildup of ice on the underside of the bottom plate.

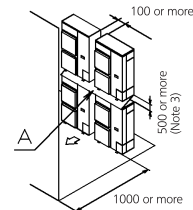

- ② Obstacle on the suction side. (1)
 - Do not exceed two levels for stacked installation.
 - Install a roof cover similar to A (field supply), as outdoor units with downward drainage are prone to dripping and freezing.
 - Install the upper-level outdoor unit so that its bottom plate is a sufficient height above the roof cover. This is to prevent the buildup of ice on the underside of the bottom plate.

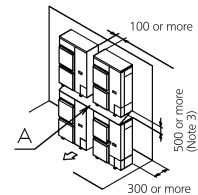

(E) Multiple rows of series installation (on the rooftop, etc.)

- ① One row of stand-alone installation

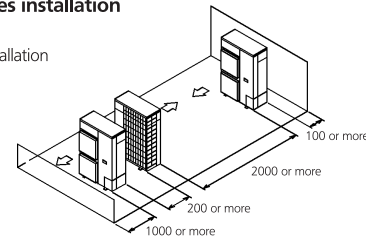

- ② Rows of series installation (2 or more)
- The relations between H, A and L are as follows.

	L	A
$L \leq H$	$L \leq 1/2 H$	250 or more
	$1/2 H < L \leq H$	300 or more
$L > H$	Can not be installed	

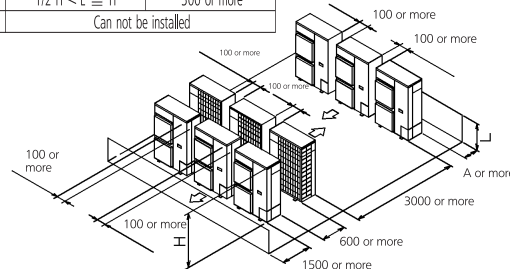

NOTES

- In case of the sideways's piping, make a 100mm gap between the unit above.
- Close the bottom of the installation frame to prevent the discharged air from being bypassed.
- It is not necessary to install a roof cover if there is no danger of drainage dripping and freezing. In this case, the space between the upper and lower outdoor units should be at least 100mm. Close off the gap between the upper and lower units so there is no re intake of discharged air.

3D069554

13 Operation range

13 - 1 Operation Range

13

RZASG-MV1
RZASG-MY1

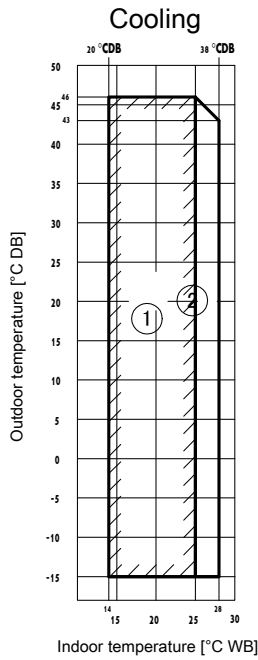

- ① Operation range
- ② Pull-down operation range
- ③ Warm-up operation range

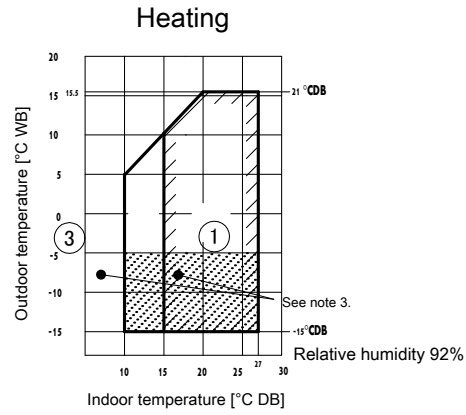

Notes

1. Depending on operation and installation conditions, the indoor unit can change over to freeze-up operation (indoor de-icing).
2. To reduce the freeze-up operation (indoor de-icing) frequency, it is recommended to install the outdoor unit in a location not exposed to wind.
3. In case of high humidity conditions (> 92%) at ambient temperatures of < -5°C, a RZAG model should be used instead to avoid freeze-up of the outdoor unit.

3D110021

14 Appropriate Indoors

14 - 1 Appropriate Indoors

AZAS-MV1
AZAS-MY1
RZAG-MV1
RZASG-MV1
RZASG-MY1

Recommended combinations
ENER Lot 21

P= Pair
2= Twin
3= Triple
4= Double twin

Notes

1. -ADEA* - can only be used in combination with -AZAS*M*V1B-

Sky Air		High Cassette				Thin cassette				2x2 cassette		Duct (medium ESP)			Concealed floor standing type			Ceiling-mounted - 4-way blow			Wall mounted type		Duct (high ESP)											
Model		FCAHG71	FCAG100	FCAG125	FCAG140	FCAG35	FCAG50	FCAG60	FCAG71	FCAG100	FCAG125	FCAG140	FFA35	FFA50	FFA60	FBA35	FBA50	FBA60	FBA71	FBA100	FBA125	FBA140	FNA35	FNA50	FNA60	FUA71	FUA100	FUA125	FAA71	FAA100	FDA125			
RZAG125M7V1B	RZAG125M7Y1B			P		4										4						P										P		
RZAG140M7V1B	RZAG140M7Y1B				P	4										4							P											
RZASG125M7V1B	RZASG125M7Y1B					4										4																P		
RZASG140M7V1B	RZASG140M7Y1B					4										4																	P	
AZAS125M7V1B	AZAS125M7Y1B																																P	
AZAS140M7V1B	AZAS140M7Y1B																																	P

Sky Air		Floor standing type				Slim duct			Ceiling-suspended				Duct (medium ESP)			Floor standing type						
Model		FVA71	FVA100	FVA125	FVA140	FDXM35	FDXM50	FDXM60	FHA35	FHA50	FHA60	FHA71	FHA100	FHA125	FHA140	ADEA35	ADEA50	ADEA60	ADEA71	ADEA100	ADEA125	AVA125
RZAG125M7V1B	RZAG125M7Y1B			P										P								
RZAG140M7V1B	RZAG140M7Y1B				P										P							
RZASG125M7V1B	RZASG125M7Y1B			P																		
RZASG140M7V1B	RZASG140M7Y1B				P																	
AZAS125M7V1B	AZAS125M7Y1B																					P
AZAS140M7V1B	AZAS140M7Y1B																					P

3D112646B

AZAS-MV1
AZAS-MY1
RZAG-MV1
RZASG-MV1
RZASG-MY1

ENER Lot 21
Appropriate indoor units

Connectable to -RZAG125M7V1B / RZAG125M7Y1B- and covered by -ENER Lot 21-

FCAHG125	FCAG35	FFA35	FBA35	FNA35	FUA125	-	-	FDA125	FVA125	FDXM35	FHA35	-	-
-	FCAG50	FFA50	FBA50	FNA50	-	-	-	-	-	FDXM50	FHA50	-	-
-	FCAG60	FFA60	FBA60	FNA60	-	-	-	-	-	FDXM60	FHA60	-	-
-	FCAG125	-	FBA125	-	-	-	-	-	-	-	FHA125	-	-

Connectable to -RZAG125M7V1B / RZASG125M7Y1B- and covered by -ENER Lot 21-

-	FCAG35	FFA35	FBA35	FNA35	FUA125	-	-	FDA125	FVA125	FDXM35	FHA35	-	-
-	FCAG50	FFA50	FBA50	FNA50	-	-	-	-	-	FDXM50	FHA50	-	-
-	FCAG60	FFA60	FBA60	FNA60	-	-	-	-	-	FDXM60	FHA60	-	-
-	FCAG125	-	FBA125	-	-	-	-	-	-	-	FHA125	-	-

Connectable to -AZAS125M7V1B / AZAS125M7Y1B- and covered by -ENER Lot 21-

-	FCAG125	-	FBA125	-	-	-	-	-	-	-	-	AVA125	ADEA125
---	---------	---	--------	---	---	---	---	---	---	---	---	--------	---------

Connectable to -RZAG140M7V1B / RZAG140M7Y1B- and covered by -ENER Lot 21-

FCAHG140	FCAG35	FFA35	FBA35	FNA35	FUA71	FAA71	-	-	FVA71	FDXM35	FHA35	-	-
-	FCAG50	FFA50	FBA50	FNA50	-	-	-	-	FVA140	FDXM50	FHA50	-	-
-	FCAG71	-	FBA71	-	-	-	-	-	-	-	FHA71	-	-
-	FCAG140	-	FBA140	-	-	-	-	-	-	-	FHA140	-	-

Connectable to -RZASG140M7V1B / RZASG140M7Y1B- and covered by -ENER Lot 21-

-	FCAG35	FFA35	FBA35	FNA35	FUA71	FAA71	-	-	FVA71	FDXM35	FHA35	-	-
-	FCAG50	FFA50	FBA50	FNA50	-	-	-	-	FVA140	FDXM50	FHA50	-	-
-	FCAG71	-	FBA71	-	-	-	-	-	-	-	FHA71	-	-
-	FCAG140	-	FBA140	-	-	-	-	-	-	-	FHA140	-	-

Connectable to -AZAS140M7V1B / AZAS140M7Y1B- and covered by -ENER Lot 21-

-	FCAG140	-	FBA140	-	-	-	-	-	-	-	-	-	-
---	---------	---	--------	---	---	---	---	---	---	---	---	---	---

ENER Lot 10
Appropriate indoor units

Connectable to -RZAG1M7V1B / RZAG1M7Y1B- and covered by -ENER Lot 10-

FCAHG71	FCAG35	FFA35	FBA35	FNA35	FUA71	FAA71	-	-	FVA71	FDXM35	FHA35	-	-
-	FCAG71	-	FBA71	-	-	-	-	-	-	-	FHA71	-	-

Connectable to -RZASG1M2V1B- and covered by -ENER Lot 10-

-	FCAG35	FFA35	FBA35	FNA35	FUA71	FAA71	-	-	FVA71	FDXM35	FHA35	-	-
-	FCAG71	-	FBA71	-	-	-	-	-	-	-	FHA71	-	-

Connectable to -AZAS1M2V1B- and covered by -ENER Lot 10-

-	FCAG71	-	FBA71	-	-	FAA71	-	-	-	-	-	-	ADEA71
---	--------	---	-------	---	---	-------	---	---	---	---	---	---	--------

Connectable to -RZAG100M7V1B / RZAG100M7Y1B- and covered by -ENER Lot 10-

FCAHG100	FCAG35	FFA35	FBA35	FNA35	FUA100	FAA100	-	-	FVA100	FDXM35	FHA35	-	-
-	FCAG50	FFA50	FBA50	FNA50	-	-	-	-	-	FDXM50	FHA50	-	-
-	FCAG100	-	FBA100	-	-	-	-	-	-	-	FHA100	-	-

Connectable to -RZASG100M7V1B / RZASG100M7Y1B- and covered by -ENER Lot 10-

-	FCAG35	FFA35	FBA35	FNA35	FUA100	FAA100	-	-	FVA100	FDXM35	FHA35	-	-
-	FCAG50	FFA50	FBA50	FNA50	-	-	-	-	-	FDXM50	FHA50	-	-
-	FCAG100	-	FBA100	-	-	-	-	-	-	-	FHA100	-	-

Connectable to -AZAS100M7V1B / AZAS100M7Y1B- and covered by -ENER Lot 10-

-	FCAG100	-	FBA100	-	-	FAA100	-	-	-	-	-	-	ADEA100
---	---------	---	--------	---	---	--------	---	---	---	---	---	---	---------

3D112646B



EEEDEN22

12/2022



The present publication is drawn up by way of information only and does not constitute an offer binding upon Daikin Europe N.V. / Daikin Central Europe HandelsGmbH. Daikin Europe N.V. / Daikin Central Europe HandelsGmbH have compiled the content of this publication to the best of their knowledge. No express or implied warranty is given for the completeness, accuracy, reliability or fitness for particular purpose of its content and the products and services presented therein. Specifications are subject to change without prior notice. Daikin Europe N.V. / Daikin Central Europe HandelsGmbH explicitly rejects any liability for any direct or indirect damage, in the broadest sense, arising from or related to the use and/or interpretation of this publication. All content is copyrighted by Daikin Europe N.V.